

City of Grants Pass Municipal Code



Title 9

LAND DEVELOPMENT AND PUBLIC IMPROVEMENTS

Chapters:

I. GENERAL PROVISIONS

- 9.01 City Utility Easements
- 9.04 City Building Codes
- 9.08 Garage Sales and Yard Sales
- 9.12 Prohibition of Fireworks, current adopted Oregon Fire Code amended
- 9.13 Open Burning Prohibited current adopted Oregon Fire Code amended
- 9.14 Weeds and Flammable Vegetation
- 9.16 Building Moving
- 9.21 Sign Standards

II. TRAILERS AND TRAILER PARKS

- 9.25 Ballot Measure 37 Procedures
- 9.28 Recreational Vehicles

III. PUBLIC IMPROVEMENTS

- 9.36 Public Improvements
- 9.37 Prequalification Requirements
- 9.40 Reimbursement Districts for Public Improvements
- 9.44 Off-Street Parking Facility Assessment

IV. HISTORIC LANDMARKS

- 9.60 Landmark List

V. MEASURE 7

- 9.99 Claims Filed Under Ballot Measure 7



City of Grants Pass Municipal Code

CHAPTER 9.01

CITY UTILITY EASEMENTS

Sections:

- 9.01.010 City Utility Easement Designation
- 9.01.020 Location of Public Utilities
- 9.01.030 Public Utilities Prohibited from Requiring Additional Easements
- 9.01.040 Location of Public Utility in Right of Way
- 9.01.050 Grade Changes
- 9.01.060 Above Ground Structures of a Public Utility
- 9.01.070 Other Structures Located Within a City Utility Easement
- 9.01.080 Grass, Asphalt, and Concrete Installed Within a City Utility Easement
- 9.01.090 Trees Planted On or Before November 5, 2003
- 9.01.100 Trees Planted After November 5, 2003
- 9.01.110 Shrubs Planted Within a City Utility Easement

# City of Grants Pass Municipal Code

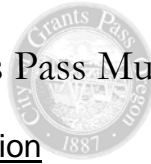

## 9.01.010 City Utility Easement Designation

- A. Where easements for water, sewer, storm drainage, electrical lines, cable television, telecommunication facilities (including, but not limited to, telephone, cellular phone, fiber optics), or other public utilities are required or necessary for development, they shall be conveyed and dedicated as City Utility Easements.
- B. Areas previously designated as public utility easements are hereby converted to City Utility Easements and subject to the terms and conditions contained in this Chapter as if they were previously designated as City Utility Easements unless there is specific and unambiguous language to the contrary in the previous dedication.
- C. Public utilities (that have a current franchise with the City or a separate temporary agreement with the City in lieu of a franchise) may be located in a City Utility Easement and as such they have the right to install, access, maintain, and operate their utility and related facilities within the Easement, including the right of access to such facilities. Public utilities with a franchise may enforce the provisions of this Chapter as to any owner or occupant of property upon which a City Utility Easement is located.

## 9.01.020 Location of Public Utilities

- A. Except for service laterals and secondary voltage extensions in excess of 400 feet that serve a single property and except for sewer and water utilities as directed by the Community Development and Utility Departments, public utilities shall locate their lines, equipment and other service related infrastructure within City Utility Easements so long as one is available or is under consideration for approval. This section shall not be interpreted to prevent a public utility from bisecting a right of way as otherwise authorized or allowed by law.
- B. After a public hearing before the Council and a finding that the public utility cannot locate within City Utility Easements or right-of-way, or it is not in the public interest for the public utility to so locate, the City Council may grant permission for a public utility to locate in an alternate location.

## 9.01.030 Public Utilities Prohibited from Requiring Additional Easements

- A. Where a public utility is capable of locating their lines, equipment and other service related infrastructure within a City Utility Easement the public utility shall not require a separate easement except in the case of secondary voltage extensions, and shall not withhold service or threaten to withhold service if a separate easement is not provided to the public utility (unless specifically required to do so by applicable regulatory or electrical code requirements).

## City of Grants Pass Municipal Code



- B. Nothing in this section prohibits a public utility from lawfully obtaining an easement from a private landowner where a private easement is necessary or desirable to provide service to that landowner or neighboring landowners and a City Utility Easement is unavailable to provide said service. A public utility shall not acquire a private easement by unlawful means or means that violate regulations of the Public Utility Commission of Oregon regarding the provision of utility service.

### 9.01.040 Location of Public Utility in Right of Way

- A. Notwithstanding 9.01.020, the City Engineer may require a public utility to locate in a portion of the public right-of-way instead of the City Utility Easement if the City Engineer determines it is not in the public interest for the public utility to locate within the City Utility Easement.
- B. If the City Engineer determines it is not in the public interest for the public utility to locate in the City Utility Easement, the City Engineer shall provide written notice to the public utility and the affected builder or developer as soon as practical to locate in the right of way.
- C. In any written notice, the City Engineer shall provide a reasonable justification for requiring the public utility to locate in the public right of way instead of the City Utility Easement. Reasonable justification includes (but is not limited to) safety concerns such as where the City Utility Easement is in a steep slope area and locating in the City Utility Easement would result in unstable soil conditions.
- D. If the City Engineer determines it is not in the public interest for the public utility to locate in the City Utility Easement, the City Engineer shall consult with the public utility and the affected builder or developer about mitigating the concerns associated with locating in the City Utility Easement (if possible) and the appropriate location within the public right of way if mitigation is not possible.

### 9.01.050 Grade Changes

Except with the written permission of all public utilities then located in the Easement, owners and occupants of property may not increase the ground level of the land within the City Utility Easement by more than 1.5 feet compared to the land adjacent to the Easement, measured from the finished grade at the time of the installation of the first utility facilities. No decrease in grade can be made by owners and occupants of property adjacent to a City Utility Easement without the written permission of all public utilities then located in that Easement. The land adjacent to a manhole, fire hydrant, or water meter located within a City Utility Easement may not be raised or lowered without the consent of the Utility Department and at the sole cost of the owner. If enforcement of this section is desired by the franchise holder, it is hereby authorized to do so in the name of the City.



City of Grants Pass Municipal Code

9.01.060 Above Ground Structures of a Public Utility

- A. Existing above ground structures of a Public Utility that are located in a utility easement as of November 5, 2003 shall not be considered in violation of this Chapter. If such a structure is changed or removed, it may be replaced within 30 days with a similarly sized structure without violating the terms of this Chapter. Otherwise, said replacement must comply with the terms of this Chapter.
- B. Above ground structures of a public utility in a City Utility Easement shall be located and sized to minimize their aesthetic impact on the adjacent properties and the neighborhood.
- C. Unless no other alternative is available (that meets specific safety and code requirements), above ground structures serving multiple properties shall be located so the edge of the structure is located within 6 feet from the side yard property line.
- D. Pad mounted transformers shall have a clearance of at least 10 feet in the front, and 3 feet at the back and sides.
- E. Fire hydrants shall have a minimum clearance of 3 feet in back, 5 feet on each side, and unrestricted clearance to the street.
- F. Except for utility poles, street lights, and fire hydrants specifically authorized by location, all above ground structures of public utilities (regardless of height or volume) shall be located further than 50 feet from a street intersection.
- G. Except as noted below, no above ground structure of a public utility shall be located in a City Utility Easement or public right of way in a residential or commercial zone when the structure exceeds 3.5 feet in height or encompasses more than 21 cubic feet in volume. This section shall not apply to industrial or BP zones.
  - 1. If a public utility desires to locate a larger above ground structure, it shall notify the City Manager in writing of said location not less than 21 days prior to installation, together with a written explanation of the reasons justifying said size.
  - 2. If a public utility desires to locate a larger above ground structure, it shall afford the City a reasonable opportunity to object to the size and location of said structure prior to the utility making its final decision on size and location.
  - 3. The City cannot deny installation of facilities in the City Utility Easement or in an alternate location acceptable to all parties. Any objection to size and location of proposed electrical and telecommunications facilities must be forwarded to the utility within 10 working days of the utility notifying the City Manager of structures being required in excess of 3.5 feet or greater than 21 cubic feet in volume.

## City of Grants Pass Municipal Code

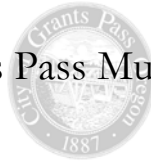

- H. Except as noted below and except for fire hydrants, above ground structures of a public utility in a residential zone that exceed 3.5 feet in height or 5.5 cubic feet in volume shall not be located within 150 feet (or within 2 adjacent property lines whichever is less) of another such structure of the same public utility. This section shall not apply to industrial or BP zones.
1. This 150 foot distance shall not apply to comparisons of facilities located on parallel streets (e.g. if structures are located on parallel streets "A" and "B", all structures on street "A" must be 150 feet apart and all structures on street "B" must be 150 feet apart, but a structure on street "A" need not be 150 feet from a structure on street "B").
  2. The 150 foot distance shall not apply to mobile home parks and housing units in excess of three residential units.
  3. If a public utility desires to locate an above ground structure closer than 150 feet, it shall notify the City Manager in writing of said location not more than 21 days after installation, together with a written explanation of the reasons justifying said location.
  4. The City cannot deny installation of facilities in the City Utility Easement or in an alternate location acceptable to all parties. Any objection to size and location of proposed electrical facilities must be forwarded to the utility within 10 working days of the utility notifying the City Manager of structures being required greater than the maximum size or less than the required distance.
- I. On and after September 4, 2003, builders, developers, and underground contractors shall not place utility infrastructure in joint trenches in a manner that is in contravention of the provisions of Chapter 9.01 and if so placed, any costs incurred by the utility for compliance related relocation shall be the responsibility of the builder, developer, or underground contractor.

### 9.01.070 Other Structures Located Within a City Utility Easement.

- A. Except for public utilities and for signs when developed in accordance with Chapter 21 (Sign Standards) of this Code, no person shall locate, construct, or continue to locate a structure (as defined in Article 30 of the Grants Pass Development Code) within a City Utility Easement. (Ord. 5434 §5, 2008)
- B. Except as set forth in Section 9.01.090, any structure located within a City Utility Easement, that obstructs or interferes with a public utility's use of the Easement may be removed by the public utility.

## City of Grants Pass Municipal Code



- C. The removal of unauthorized structures shall be at the sole cost of the owner or occupant of the property upon the written request of the City Manager or the public utility. Owners and occupants of property shall not be entitled to any compensation for damages related to removal of unauthorized structures.
- D. Except for the removal of structures at the request of the City as part of a public safety concern or a public improvement project, the removal and replacement or relocation of authorized structures shall be at the sole cost of the public utility requesting removal. However, owners and occupants of property shall not be entitled to compensation for damages related to removal of the authorized structures.
- E. Fencing, concrete block walls/fencing, retaining walls, and similar fencing/wall structures that are otherwise in compliance with the Development Code, and with the clearance provisions noted herein, may be built over an easement subject to the following requirement:
  - 1. Said fencing or wall structures that interfere with the installation, maintenance, access, or operation of a public utility may be removed by the utility at the sole cost of the utility.
  - 2. Any replacement or relocation of the fencing or wall structures shall be at the sole cost of the property owner or occupant.
  - 3. Owners and occupants of property shall not be entitled to compensation for damages related to removal of the fencing or wall structures.

### 9.01.080 Grass, Asphalt, and Concrete Installed Within a City Utility Easement

- A. Subject to the limitations of the Development Code, lawful owners and occupants of property may install grass, asphalt and concrete within a City Utility Easement.
- B. In the course of installing, accessing, maintaining, or operating its facilities in a City Utility Easement, a public utility may move or remove any asphalt, concrete, or vegetation. After the same are moved or removed and after completion of the necessary work, the grass, asphalt or concrete shall be repaired and replaced in a reasonable manner at the sole cost of the public utility.
- C. Owners and occupants of property shall not be entitled to compensation related to damages to grass, asphalt, or concrete so long as the repairs and replacement are done in a reasonable manner and in a reasonable time frame.

# City of Grants Pass Municipal Code

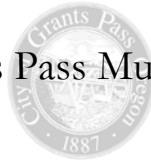

## 9.01.090 Trees Planted Within a City Utility Easement on or Before November 5, 2003

- A. Any trees planted within a City Utility Easement on or before November 5, 2003 that obstruct or interfere with a public utility's use of the Easement shall be subject to reasonable pruning (at the sole cost of the public utility) when necessary for the safe operation of the public utilities located therein. (Note: Other provisions of the Municipal Code prescribe rules for pruning trees, including arborist requirements.) In such cases, owners and occupants of property shall not be entitled to compensation for damages related to the pruning so long as it is done in a reasonable manner and in compliance with other provisions of the Municipal Code.
- B. Trees planted within a City Utility Easement that damage or prevent access to a public utility located within the Easement may be removed. In such cases, owners and occupants of property shall not be entitled to compensation for damages related to the removal so long as it is done in a reasonable manner and in compliance with other provisions of the Municipal Code.

## 9.01.100 Trees Planted Within a City Utility Easement After November 5, 2003.

- A. In the course of installing, accessing, maintaining, or operating its facilities, a public utility may remove a tree planted in a City Utility Easement after November 5, 2003.
- B. Owners and occupants of property shall not be entitled to compensation from a public utility for damage, removal, or death to trees located within the City Utility Easement that are planted after November 5, 2003 when the damage or death of the tree was related to installing, accessing, maintaining, or operating the facilities of the public utility.

## 9.01.110 Shrubs Planted Within a City Utility Easement

- A. Subject to the requirements of the Development Code, owners and occupants of property may install non-invasive shrubs within a City Utility Easement so long as the shrubs do not exceed 4 feet in height at the time of planting and do not block access to above ground utility facilities or entrances to below ground utility facilities.
- B. A "non-invasive shrub" is one with a root system that is average or below average with regard to its tendency to be invasive to underground utilities.
  - 1. Subject to the limitations noted below, in the course of installing, accessing, maintaining, or operating its facilities in a City Utility Easement, a public utility may move or remove any shrubs within the Easement.
  - 2. Prior to completion of the necessary work, the public utility shall take reasonable steps to preserve non-invasive shrubs 4 feet or less in height (at the time of removal) at the sole cost of the public utility.



## City of Grants Pass Municipal Code

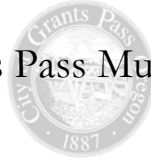

3. After completion of the necessary work, any non-invasive shrubs (still alive) 4 feet or less in height shall be replanted at the sole cost of the public utility.
4. After completion of the necessary work (or within 9 months of replanting), if any non-invasive shrubs suffer severe damage or death, they shall be replaced with a similar non-invasive species and size shrub up to 4 feet in height at the sole cost of the public utility.
5. After completion of the necessary work, any shrub that exceeded 4 feet in height when removed shall be replaced with a similar non-invasive species shrub of not less than 3 feet in height at the sole cost of the public utility.
6. Except for the replacement vegetation requirements noted herein, owners and occupants of property shall not be entitled to compensation for shrubs planted within the City Utility Easement.
7. Shrubs planted within a City Utility Easement that damage a public utility located within the Easement may be removed. In such cases, owners and occupants of property shall not be entitled to compensation for damages related to the removal so long as it is done in a reasonable manner and in compliance with other provisions of the Municipal Code.

# City of Grants Pass Municipal Code



## I. GENERAL PROVISIONS

### Chapter 9.04

#### CITY BUILDING CODES

#### Sections:

- 9.04.010 Adoption of City Building Code and Short Title
- 9.04.020 Repository
- 9.04.100 Conflicts
- 9.04.200 Conformance to City Building Code Requirements
- 9.04.300 Authority
- 9.04.400 Appeals
- 9.04.500 Fees

# City of Grants Pass Municipal Code



## 9.04.010 Adoptions of City Building Code and Short Title

Chapter 9.04 shall be referred to as the City Building Code. Except as specifically limited in this Chapter, the following codes are hereby adopted, and made a part of Chapter 9.04 of the Municipal Code. The Codes listed below shall be updated automatically as the same are modified by the State of Oregon from time to time.

- A. The 2010 Oregon Structural Specialty Code, consisting of 1 volume and reference standards, and appendix chapters specifically adopted by the State of Oregon; and Appendix J; and (Ord. 5407, 06/06/07; Ord. 5454, 07/02/08)
- B. The 2011 Oregon Residential Specialty Code, including all appendix chapters specifically adopted by the State of Oregon; and
- C. The 2011 Oregon Plumbing Specialty Code, including all sections and appendix chapters specifically adopted by the State of Oregon; and
- D. The 2010 Oregon, Mechanical Specialty Code, and appendix chapters specifically adopted by the State of Oregon; and
- E. The 2010 Oregon Fire Code, and appendix chapters specifically adopted by the State of Oregon; and
- F. The 2011 Oregon Electrical Specialty Code, and appendix chapters specifically adopted by the State of Oregon with electric permit fees in conformance with OAR 918-309-000 through 0090; and
- G. The 2010 Oregon Energy Efficiency Specialty Code; and
- H. The 2011 Oregon Reach Code; and
- I. The 2010 Oregon Solar Installation Specialty Code; and
- J. The 2002 Oregon Manufactured Dwelling and Parks Specialty Code; and
- K. The 2010 Oregon Manufactured Dwelling Installation Specialty Code; and
- L. The Uniform Housing Code, 1997 Edition; and
- M. The Uniform Code for the Abatement of Dangerous Buildings, 1997 Edition; and
- N. Oregon Administrative Rules, Chapter 918 in effect on January 1, 2014, as may be amended from time to time by the Building Codes Division of the Department of Consumer and Business Services.

# City of Grants Pass Municipal Code

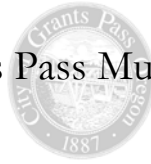

## 9.04.020 Repository

A copy of the items noted in the City Building Code shall be kept on file at the office of the City's Building Code Official and a copy of the State of Oregon Fire Code, and appendix chapters specifically adopted by the State of Oregon shall be kept on file at the office of the person designated by the Public Safety Director to act in the capacity of Fire Marshall or Fire Prevention Officer.

## 9.04.100 Conflicts

- A. In the event of conflicts between or among provisions of the City Building Code, the most restrictive provision shall apply.
- B. Interpretations of the City Building Code shall be made, and conflicts therein resolved, by the City Building Official, subject to appeal as set forth in this Chapter.

## 9.04.200 Conformance to City Building Code Requirements

- A. All new construction shall conform to the requirements of the City Building Code.
- B. Unsafe structures, regardless of the date of construction, shall conform to the requirements of the City Building Code.

## 9.04.300 Authority

The City Building Official, and any other person designated by the City Building Official with the approval of the City Manager are authorized to institute appropriate action to prevent, restrain, correct or abate a violation regarding existing or new construction and to enforce the provisions of this City Building Code. The Public Safety Director and any designees are authorized to enforce the provisions of the State of Oregon International Fire Code, and appendix chapters specifically adopted by the State of Oregon.

## 9.04.400 Appeals

Appeals of the Plans Examiner/Inspector: When there is an appeal of a plans examiner or inspector's interpretation of the Building Code during plan review or inspection, the following process is followed:

- A. Initial Appeal to the Building Official:

In an informal appeal of a plans examiner / inspector decision, the plans examiner / inspector refers the request and any related information to the Building Official, who, in consultation with plans examiner / inspector and other appropriate staff, reviews the request and provides a final determination to the applicant (in writing if requested).

# City of Grants Pass Municipal Code



## B. Appeals of the Building Official:

A person aggrieved by a decision made by the Building Official under authority established pursuant to ORS 455.148, 445.150, or 455.467 may appeal the decision in the manner provided by ORS 455.475. If an appeal is made under this section, the Building Official shall extend the plan review deadline by the number of days it takes for a final decision to be issued for appeal.

### 9.04.500 Fees

Fees charged under the City Building Code will be established by Resolution adopted by the City Council consistent with State Administrative Rules. (Ord. 5468 §15, 2008).

City of Grants Pass Municipal Code

Chapter 9.08

GARAGE SALES AND YARD SALES

Sections:

- 9.08.010 Permitted Use
- 9.08.020 Length of Sales
- 9.08.030 Frequency
- 9.08.040 Site Permission
- 9.08.050 Signs
- 9.08.990 Penalties

# City of Grants Pass Municipal Code



## 9.08.010 Permitted Use

Garage sales and yard sales hereinafter referred to in this Chapter as sales are permitted in Residential Zones without a major home occupation permit or other permit, provided they comply with the standards set forth in Sections 9.08.010 through and including 9.08.990.

## 9.08.020 Length of Sales

Sales may be no longer than 3 continuous days.

## 9.08.030 Frequency

- A. Sales may be held no more than 2 times per month.
- B. Sales may be held no more than 6 times per year.

## 9.08.040 Site Permission

- A. Sales shall be conducted on property which is regularly occupied by the person conducting the sale.
- B. Multiple family sales are permitted if the sales are held on the property of one of the participants.
- C. Sales may not occur or encroach upon City streets, sidewalks, or other right of way.

## 9.08.050 Signs

- A. A combined total of 6 directional or advertising signs may be used for a sale.
- B. Not more than 2 of the signs may be placed on City street or sidewalk right-of-way but said signs must be located outside of the traveled portion of a roadway and may not obstruct or impair pedestrian traffic on a sidewalk.
- C. Signs may be placed on another's property with the property owners permission.
- D. Signs may be no larger than 3 square feet each.
- E. Signs may be placed not sooner than 24 hours before the sale and must be removed within 1 hour after closing on the final day of the sale.
- F. Signs may not be placed in any manner which would be in violation of section 9.21.047 E of this Code. (Ord. 5456 §2, 2008)

# City of Grants Pass Municipal Code



## 9.08.990 Penalties

- A. A person who violates any provision of this Chapter may be prosecuted in District or Municipal Court.
- B. A violation of this Chapter shall be punishable by a fine not less than \$25 nor more than \$250.



City of Grants Pass Municipal Code



Chapter 9.12

FIRE CODE

Sections:

9.12.270 Prohibition of Fireworks, UFC Section 78.102 Amended  
(Ord. 4895 §1, 1997) (Ord. 15-5641, 2015)

9.12.270 Prohibition of Fireworks

Current adopted Oregon Fire Code is amended to add the following language:

Any manufacture, sale, or discharge of fireworks is prohibited except as follows:

- A. Fireworks for public displays by permit, as provided in OAR 837-012-0700 for Supervised Public Displays of Fireworks are authorized.
- B. Use of fireworks, otherwise legal under State law, is permitted on July 4, between the hours of 6:00 p.m. and 11:00 p.m. except in the areas identified in Section D below.
- C. In the areas identified as Wildfire Hazard Areas, the use and discharge of fireworks is not allowed at any time. A map(s) identifying the Wildfire Hazard Areas shall be made available to the public at the Fire Prevention Office as well as on the City web site.
- D. Notwithstanding any provision to the contrary, the use and discharge of fireworks of whatever kind is prohibited in the following areas:
  1. The area west of NW Highland and NW Dimmick, which is north of the railroad tracks.
  2. The area north of Interstate 5.
  3. All City parks.
  4. Any public school.
  5. Any area where a fire hazard or potential to cause a fire exists as determined by the Fire Marshal or designee.

# City of Grants Pass Municipal Code

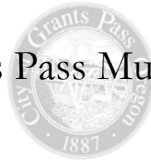

## Chapter 9.13

### OPEN BURNING PROHIBITED

#### Sections:

- 9.13.100 Permit Requirement Exceptions, current adopted Oregon Fire Code amended
- 9.13.200 Open Burning Prohibited
- 9.13.210 Permits and Restrictions for Residential Open Burning
- 9.13.300 Wildfire Fuels Mitigation Open Burning
- 9.13.500 Liability for Fire Response

#### 9.13.100 Required Permits Current adopted Oregon Fire Code(OFC) amended

(Ord. 15-5641 2015)

Any property owner or authorized agent who intends to conduct an operation or business, or install or modify systems and equipment which is regulated by the Oregon Fire Code (OFC), or to cause any such work to be done, shall first make application to the Fire Prevention Office and obtain the required permit. The following list is not all inclusive. Contact the Fire Prevention Office for further information. (Ord. 5379 § 18, 2006) (Ord. 15-5641 2015)

The following Operational and Construction Permits are required in this jurisdiction.

#### Operational Permits:

##### OFC

- 105.6B Fireworks, public display of
- 105.6.2 Amusement Buildings (haunted houses)
- 105.6.4 Carnivals & Fairs
- 105.6.10 Cryogenic Fluids per OFC table 105.6.10
- 105.6.13 Exhibits & Trade Shows
- 105.6.14 Explosives
- 105.6.16 Flammable & Combustible liquids
- 105.6.20 Hazardous Materials per OFC table 105.6.20
- 105.6.29 Miscellaneous Combustible Storage
- 105.6.30 Open Burning

#### Construction Permits:

Prior to issuance of the following permits, construction documents and supporting data shall be submitted in two sets. Construction documents shall be prepared by a registered design professional.

#### Exception:

The fire code official is authorized to waive the submission of construction documents and supporting data not required to be prepared by a registered design professional if it is found that the nature of the work applied for is such that review of construction documents

Title 9 Last Revised 05.5.17



# City of Grants Pass Municipal Code

is not necessary to obtain compliance with this code.

- 105.7.1 Automatic fire-extinguishing systems
- 105.7.5 Emergency Responder Radio Coverage
- 105.7.6 Fire alarm and detection systems and related equipment
- 105.7.7 Fire pumps and related equipment
- 105.7.9 Hazardous Materials per OFC table 105.6.20
- 105.7.11 LP Gas
- 105.7.12 Private Fire Hydrants
- 105.7.16 Temporary Membrane Structures & Tents

## 9.13.150 Fire Plan Review

Upon receiving a certificate of occupancy for construction projects requiring a fire and life safety plans review, one (1) set of “As Built” plans shall be submitted to the Fire Prevention Office. Plans shall be submitted in the DWF or DWFX file format.

## 9.13.200 Open Burning Prohibited

- A. Except as provided herein, no person shall start or maintain any fire outside a building for the purpose of burning any material or cause or participate therein, nor shall any person in control of any premises cause or allow any such fire to be started or maintained on any part of said premises.
  - 1. This section does not apply to, barbecues, outdoor fireplaces, fire pits or outdoor cooking fires where the material used for burning is propane, natural gas, charcoal briquettes, or wood.
    - a. Freestanding devices such as manufactured fire pits or Chimeneas shall be placed on a non-combustible surface that extends at least 16 inches beyond the front edge of the opening and at least 8 inches beyond the side of the firebox opening.
    - b. Manufactured devices shall be installed and used according to the manufacturer’s instructions.
  - 2. This section does not apply to the burning of branches, blackberry vines, leaves, grass and other dry vegetation material under a conditional permit granted pursuant to Section 9.13.210 or Section 9.13.300. This permit shall not include permission to burn wood products.
  - 3. This section does not apply to the burning of a structure or the other use of fire for training purposes conducted by the Public Safety Department with a permit.



## City of Grants Pass Municipal Code

4. This section does not apply to ceremonial fires for which a fire is appropriate and a conditional permit has been issued. There is no charge for the permit. Prior to conducting a ceremonial fire, the Fire Marshal or designee shall inspect the location of the proposed ceremonial fire and if approved, issue the permit.
- B. The Fire Marshal or designee is hereby authorized to issue requirements for any such permit including, but not limited to, bonding or insurance, supervision, crowd control, fire control equipment and personnel, size, duration, composition, date, time, and location.
  - C. A permit may be revoked or denied by the Fire Marshal, or designee, based upon the threat to persons or property, air quality standards, weather conditions, or failure or inability to comply with permit requirements.
  - D. Fires must be started and maintained in accordance with the terms of the permit and any other requirements of this Code.
  - E. No permit will be issued where burning would violate Oregon Administrative Rules governing open burning in the Rogue Basin Open Burning Control Area.
  - F. The Fire Marshal or designee shall not approve outside burning on any day if he/she determines that low humidity, high winds, drought, or other weather or other unusual conditions exist which make outside burning generally, or at the particular time and place proposed, unreasonably hazardous to the safety of persons or property. In no event shall the Fire Marshal approve outside burning on a day when one or more of the following conditions exist, or in his/her determination will exist:
    - a. Temperature above 90 degrees F.
    - b. Wind above 20 MPH.
    - c. Humidity below 30 percent.
  - G. The Fire Marshal or designee may approve outside burning on any day the ventilation index is or will be greater than 400 during that day. The ventilation index is the National Weather Service's indicator of the relative degree of air circulation for the Grants Pass area.
  - H. Outside burning without a permit is hereby declared to be a public nuisance and may be summarily abated by the Fire Marshal or designee.

### 9.13.210 Permits and Restrictions for Residential Open Burning.

(Ord. 15-5641 2015)

- A. Permit: Open burning of yard debris, i.e. branches, blackberry vines, leaves, grass, and other dry vegetation material, is authorized for residential properties with a permit issued by the Fire Prevention Office.

Title 9 Last Revised 05.5.17

# City of Grants Pass Municipal Code

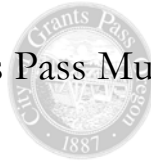

- B. Duration of Permit: Permits for open burning may be issued for up to 9 consecutive days. (Ord. 5229, 2004) (Ord. 15.5641 2015)
- C. Fees: The fee for each permit shall be \$10 to cover costs to the Fire Prevention Office to administer the program. Permit fees are non-refundable.
- D. Obtaining Permits: Permits may be obtained at the Fire Prevention Office during the advertised days and times.
- E. Season of Burning: Open burning pursuant to a permit shall be permitted during a consecutive 9-day period that includes two weekends, once in the spring and once in the fall, subject to the following limitations: (Ord. 5229, 2004)
- F. The periods shall be designated by the Fire Marshal. In designating the periods, consideration is given to such factors as the temperature, wind speed, air ventilation index , moisture levels, and fire danger in the City. (Ord. 5229, 2004)
- G. Permit Restrictions: (Ord. 5229, 2004) (Ord. 15-5641, 2015)
  - 1. A person possessing a permit may not open burn if the ventilation index, as determined by the National Weather Service, is below 400.
  - 2. A person who is burning pursuant to a permit shall maintain adequate fire suppression equipment and supplies as required by the Fire Prevention Office.
  - 3. A person who is burning pursuant to a permit shall maintain continuous competent adult supervision over the burn site while materials are burning or smoldering.
  - 4. When open burning creates or adds to a hazardous or objectionable situation, the Fire Marshal or designee is authorized to order the extinguishment of the open burning operation.
  - 5. Open burning pursuant to a permit shall not be conducted or continue after sunset or before sunrise.

## 9.13.300 Permits and Restrictions for Wildfire Fuels Mitigation Open Burning

(Ord. 15-5641 2015)

Destructive wildfires have become more common, more damaging and more costly. In the Wildfire Hazard Areas, wildfire fuels reduction projects are performed to remove hazardous fuels from properties to help reduce the wildfire risk to residential areas. Occasionally, these projects are performed on property which does not have access to roads where the cut material can be readily removed or chipped for disposal. In these situations, the burning of cut, piled vegetation is authorized by permit.

Title 9 Last Revised 05.5.17



## City of Grants Pass Municipal Code

- A. Permit: Issued by the Fire Marshal or designee for projects which do not have access for removal or chipping. Open burning of piled vegetation i.e. branches, brush, blackberry vines, and other dry vegetation material, is authorized for properties located within the Wildfire Hazard Areas identified by the Fire Rescue Bureau.
- B. Duration of Permit: Permits for open burning may be issued for a reasonable period of time as determined by the Fire Marshal not to exceed seven (7) days.
- C. Fees: The fee for each permit shall be \$50.00 to cover costs to the Fire Prevention Office for the site inspections and to administer the program.
- D. Obtaining Permits: Permits may be obtained at the Fire Prevention Office during regular business hours, Monday through Friday. A Hazardous Fuels Mitigation Site Operation Plan must be submitted and approved by the Fire Marshal prior to obtaining a permit.
- E. Season of Burning: Open burning pursuant to a permit shall be designated by the Fire Marshal. In designating the periods, consideration is given to such factors as the temperature, vegetation, air ventilation index, wind speed, moisture levels, and fire danger in the City.
- F. Permit Restrictions:
  - 1. A person possessing a permit may not open burn if the ventilation index, as determined by the National Weather Service, is below 400.
  - 2. A person who is burning pursuant to a permit shall maintain adequate fire suppression equipment and supplies as required by the Fire Marshal or designee.
  - 3. A person who is burning pursuant to a permit shall maintain continuous, competent adult supervision over the burn site while materials are burning or smoldering.
  - 4. When open burning creates or adds to a hazardous or objectionable situation, the Fire Marshal or his designee is authorized to order the extinguishment of the open burning operation.
  - 5. Open burning pursuant to a permit shall not be conducted or continue after sunset or before sunrise.
  - 6. All piling and burning of materials pursuant to a permit shall be conducted according to local industry practices for wildfire fuels mitigation.

# City of Grants Pass Municipal Code



## 9.13.500 Liability for Fire Response

In addition to all other liabilities which are applicable, a person who open burns, either with or without a permit, shall be personally liable to the City of Grants Pass for all costs incurred by the Fire/Rescue Bureau of the Public Safety Department in suppressing any fire or fires which are associated with open burning by the person. (Ord. 15-5641 2015)



City of Grants Pass Municipal Code

Chapter 9.14

OPEN BURNING PROHIBITED

Sections:

9.14 Weeds and Flammable Vegetation

9.14.100 Weeds and Flammable Vegetation

(Ord. 15-5641 2015)

The accumulation of tall dry grass and highly combustible vegetation constitutes a hazard to adjoining properties and the potential to spread a wild fire. It is the responsibility of every property owner and / or person in charge of property to reduce vegetation (grass, vines, weeds, brush and other vegetation) which is currently or potentially a wildfire hazard. A wildfire hazard is a condition or element that provides a source of ignition or contributes to the spread of and severity of fire as determined by the Fire Marshal.

The Fire Marshal or designee shall determine when conditions of the environment deem it necessary to invoke regulated restrictions, closures and aggressive control of vegetation constituting a fire hazard. The duration of this time period shall be until there is no longer a threat of fire danger, as determined by the Fire Marshal. The time periods for regulated restrictions and closures typically mirrors those of the Oregon Department of Forestry.

- A. It is the responsibility of every property owner and/or the person in charge of a property to reduce flammable or potentially flammable weeds, grass, vines, brush or other vegetation on the property by complying with the requirements of this chapter. The purpose of the flammable vegetation reduction shall be to protect property from wildfire by confining fire and preventing its spread to other properties.
- B. Weeds, grass, vines, brush or other growth that is capable of being ignited and endangering property, shall be cut down and removed by the property owner or occupant. Vegetation clearance shall be in accordance with the International Wildland – Urban Interface Code.
- C. Every property owner and/or person in charge of property shall reduce and maintain the reduction of flammable or potentially flammable vegetation on the property in the following manner:
  1. A reduction can be completed with a combination of trimming, cutting or removing flammable or potentially flammable weeds, grass, vines, brush and other combustible vegetation as close to the ground as is reasonably practicable given the nature of the terrain and the property, or by the application of an EPA-approved herbicide.





## City of Grants Pass Municipal Code

2. Any tax lot greater than one-half acre (21,780 square feet) shall establish and maintain a 20-foot fuel break along the entire perimeter of the property, including all rights-of-way or easements. Fuel breaks shall be located along the boundaries of the property, and also around any structures or other improvements to the property that would be vulnerable to a fire hazard created by flammable or combustible vegetation.
- D. The Fire Marshal or designee may direct additional abatement for any situations not adequately covered by the fuel breaks described above.
  - E. Flammable vegetation located in the right-of-way or easement shall be the responsibility of the adjacent property owner and/or person in charge of the property.
  - F. Accumulated cut/waste vegetation shall be disposed of in a manner so as not to create a fire hazard or spread vegetation to other properties.

No owner or person in charge of a property shall allow a dead or decaying tree to stand if it is a hazard to the public or persons or property on or near the property.



City of Grants Pass Municipal Code

Chapter 9.16

BUILDING MOVING

Sections:

- 9.16.010 Permit Requirements
- 9.16.020 Time of Moving
- 9.16.030 Pneumatic Tired Equipment Requirement

9.16.010 Permit Requirements

No person, firm or corporation except a licensed building mover shall remove or move, from one lot to another, any building or part of a building within the City without obtaining a permit therefore from the City. A processing fee of \$100 shall be paid at the time of a permit application. The licensed builder mover shall be responsible for coordinating utility issues and providing adequate traffic control devices and personnel to insure the safety of vehicles and pedestrians and shall provide the City with the route plan at the time the application is made. (Ord. 1674 §1, 1950; Ord. 4833 §3, 1995)

9.16.020 Time of Moving

The moving of any building or part of a building is prohibited from 6:00 a.m. to 6:00 p.m. unless prior to the move, a different time is approved in writing by the City Manager. (Ord. 4833 §3, 1995)

9.16.030 Pneumatic Tired Equipment Requirement

A building or part of a building being moved over or across any street, alley or other public property shall be supported by pneumatic tired equipment of sufficient size to reasonably carry the load being moved without damage to the surface on which the load is being moved. (Ord. 4833 §3, 1995)

# City of Grants Pass Municipal Code



Chapter 9.21 has been added by Ord. 4952 §2, 1998

## Chapter 9.21

### SIGN STANDARDS

#### Sections:

9.21.010	Purpose
9.21.020	Definitions
9.21.030	Computations
9.21.040	Permits Required
9.21.041	Signs Exempt From Permits
9.21.042	Application
9.21.043	Issuance of Permits
9.21.044	Installation
9.21.045	Permit Fee/No-Fee
9.21.046	Indemnification of City
9.21.047	Prohibited Signs
9.21.048	Abandoned Signs
9.21.050	Dangerous Signs
9.21.060	Signs in the General Commercial Zone
9.21.070	Signs in a Freeway Overlay Zone
9.21.080	Signs in a Neighborhood Commercial Zone
9.21.090	Signs in Residential Zones
9.21.100	Signs for a Shopping Center
9.21.110	Signs in Industrial Zones
9.21.120	Signs in the Central Business District
9.21.121	Signs in the Historic District
9.21.122	Downtown Mall Sign
9.21.130	Freestanding Signs within a City Utility Easement
9.21.300	Signs for a Fairgrounds
9.21.400	Signs for Regional Hospitals, Schools, and All Sports Parks
9.21.500	Special Signs for all Commercial and Industrial Zones
9.21.600	Temporary Political Signs
9.21.610	Temporary Political Signs Defined
9.21.620	General Placement Rules for all Temporary Political Signs
9.21.630	Temporary Political Signs in Industrial and Commercial Zones
9.21.640	Temporary Political Signs in Residential Zones
9.21.650	Enforcement
9.21.700	Grandfather Clause
9.21.750	Heritage Markers
9.21.755	Heritage Markers Located on Private Property
9.21.760	Heritage Markers Located on Public Property
9.21.800	Appeal

# City of Grants Pass Municipal Code

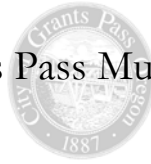

## 9.21.010 Purpose

- A. The purposes of this Chapter are to:
1. Protect the health, safety, property and welfare of the public;
  2. Provide a neat, clean, orderly and attractive appearance of the community;
  3. Improve the effectiveness of signs;
  4. Provide for safe construction, location, erection and maintenance of signs;
  5. Prevent proliferation of signs and sign clutter, minimize adverse visual safety factors to travelers on public highways and on private areas open to public travel;
  6. Improve the ability of business owners/lessees to identify their businesses to the community to enhance the furtherance of commerce; and
  7. Achieve these purposes consistent with state and federal constitutional limits on the regulation of speech.

To achieve these purposes, it is necessary to regulate the design, quality of materials, construction, location, electrification, illumination, and maintenance of signs that are visible from public property, public rights of way and private areas open to public travel. (Ord. 5466 §3, 2008)

## 9.21.020 Definitions

- A. Abandoned Sign: A sign that advertises a business or event that has been closed for more than 30 days.
- B. Alteration: Any modification of a sign excluding routine maintenance, painting or change of commercial message of an existing sign.
- C. Animated Sign: Any sign that uses movement or change of lighting to depict action or create a special effect or scene.
- D. Attached Sign: A sign attached to or painted on any part of a building as contrasted to a freestanding sign.
- E. Awning or Canopy Sign: Any sign painted on or applied to the surface of an awning or canopy.
- F. Banner: A strip of cloth or other material bearing a design, slogan or message typically hung by string or rope.

## City of Grants Pass Municipal Code



- G. Billboard: A sign located on a zone lot not containing a building.
- H. Blade Sign: A sign that is perpendicular to a store frontage, usually hangs from a canopy or awning.
- I. Building Frontage: A lineal front of a building or portion thereof devoted to a specific business or enterprise that fronts a street or customer parking area.
- J. Changing Image Sign: Any sign that, through the use of moving structural elements, flashing or sequential lights, lighting elements, or other automated method, results in movement, the appearance of movement or change of sign image or message. Changing image signs do not include otherwise static signs where illumination is turned off and back on not more than once every 24 hours, nor signs with manually changeable copy/text. (Ord. 5424 §5, 2008)
- K. Commercial Message: Any sign wording, logo. Note: the paint scheme of a building will not be considered as part of a commercial message.
- L. Directional Sign: Signs limited to directional messages, principally for pedestrian or vehicular traffic, such as 'One Way', 'Entrance' and 'Exit'.
- M. Directory Sign - A sign, oriented for pedestrian traffic that lists the names or locations of various businesses or activities located in a building or group of buildings. Directory signs shall be limited to one per building entrance or one per street frontage, whichever is less. Directory signs shall have a maximum size of 3 square feet if the sign is visible from a public right of way. (Ord. 4970 §1, 1999)
- N. Double-Faced Sign: A sign with a commercial message on two sides.
- O. Downtown Mall: A shopping area in the Central Business District which includes a minimum of three separately taxed businesses, which share common pedestrian entrances.
- P. Drive-Up Service Sign: A sign for a drive-up service such as a menu board for fast food restaurants, ATM or listing of any other services.
- Q. Electric Sign: Any sign which has electrical wiring in, on, or attached to it.
- R. Flag: Any fabric, banner, or bunting containing distinctive colors, patterns or symbols used as a symbol of government. A flag is not considered a sign.
- S. Freestanding/Ground Sign: A sign anchored in the ground and independent from any building.
- T. Government Sign: A sign installed by a public agency for the purpose of public information. This includes stop signs, directional signs, warning signs and other



## City of Grants Pass Municipal Code

notification that is in the interest of public health, safety and welfare.

- U. Grade: The final grade of paving, sidewalk or landscaped area at any given point upon completion of construction. (Grants Pass Development Code, Article 30.)
- V. Internally Illuminated: Any sign which has the source of light entirely enclosed within it. Source may be fluorescent lamps, incandescent bulbs, neon tubing etc.
- W. Historic Advertising Art: Artwork that contains advertising for a specific company or product and can be proven to have actually existed at least fifty years ago.
- X. Marquee: A structure attached to and supported by a building that can project over the public right-of-way.
- Y. Mural: Artwork that contains no advertising message or content and does not represent a company or product(s).
- Z. Non-Conforming Sign: A sign that does not conform to the requirements of this Code.
- AA. Owner/Lessee: The owner, lessee or authorized designee of the lot or building.
- BB. Pennant: A lightweight plastic or fabric, suspended from a rope, wire, or string, usually in series, designed to move in the wind.
- CC. Election Sign: A temporary sign usually used to represent a candidate or an issue, restricted to the time frame immediately surrounding a State sanctioned election.
- DD. Project Sign: A sign located at the site of a construction project.
- EE. Projecting Sign: A sign other than a wall sign that projects from and is supported by a wall of a building or structure.
- FF. Real Estate Sign: A sign used to indicate the lot or business on which the sign is located is for sale, lease or rent.
- GG. Residential Sign: A sign located in a residential zone.
- HH. Secondary Outdoor Business: An additional business located outside of the structure in which the principal business resides, usually in the parking area.
- II. Setback: The minimum horizontal distance from a given point or line of reference, which, for purposes of this Code unless otherwise stated, shall be the



## City of Grants Pass Municipal Code

lot line, to the nearest edge of a building or structure, fence, or other elements as defined by the Grants Pass Development Code.

- JJ. Shopping Center: A retail complex including at least six separately taxed businesses which are located on one or more lots and which share parking area and driveway entrances.
- KK. Sign: A device, fixture, placard, painting or structure that uses color, form, graphic, illumination, symbol or writing to advertise, announce, identify or communicate information.
- LL. Sign Structure: A structure specifically intended for supporting or containing a sign. (Ord. 5434 §5, 2008)
- MM. Street Frontage: The lineal dimension in feet that the property upon which a structure is built abuts a public street or streets.
- NN. Temporary Sign: A sign which is erected for a limited period of time.
- OO. Temporary Sign Displays: An attention attracting device or devices, including but not limited to, flags (non-governmental), pennants, streamers, lawn signs, balloons, inflatable objects, and air powered objects.
- PP. Visual Clearance Area: The area located at a corner, intersection or driveway that is required for proper visibility from a motorized vehicle or by a pedestrian. (Grants Pass Development Code Article 30)
- QQ. Wall Sign: Any sign placed or painted directly against a building with the exposed face of the sign in a plane approximately parallel to the plane of said wall and projects outward from the wall not more than 18 inches.
- RR. Window Sign: A sign affixed to the inside or outside of the glass of a window or door.

# City of Grants Pass Municipal Code

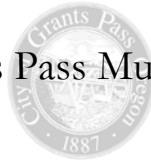

## 9.21.030 Computations

- A. Computation of the area of a freestanding or projecting sign shall be calculated by adding the square footage of all the faces presenting a commercial message. Pole covers and columns shall not be included in the area of the measurement if they do not bear a commercial message. For signs 100 square feet or less per face, double-faced signs will be calculated as one sign only when placed back-to-back, with each outside face separated by no more than 30 inches. For signs greater than 100 square feet per face, double-faced signs will be calculated as one sign only when placed back-to-back, with each outside face separated by no more than 36 inches. See figures below: (Ord. 5434 §5, 2008)

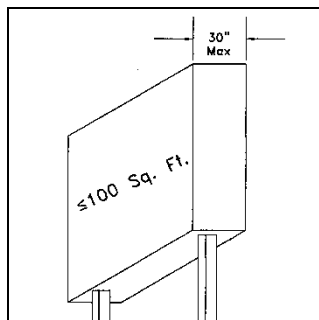

*Double-faced signs (100 sq. ft. or less per face) will be calculated as one sign only when placed back-to-back, with each outside face separated by 30 inches or less.*

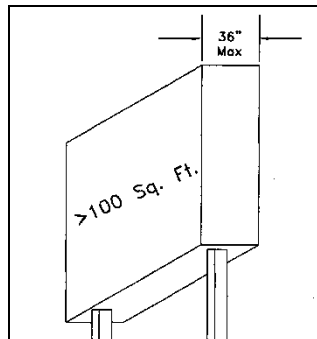

*Double-faced signs (greater than 100 sq. ft. per face) will be calculated as one sign only when placed back-to-back, with each outside face separated by 36 inches or less.*

- B. The area of a wall sign shall be computed by enclosing the entire commercial message, including logo, within sets of parallel lines touching the outer limits of the commercial message.



# City of Grants Pass Municipal Code



- C. Computation of the height of a freestanding sign will be the vertical distance measured between the elevation of the ground directly below the horizontal center of the sign face and the highest point of the sign structure. See figure below:

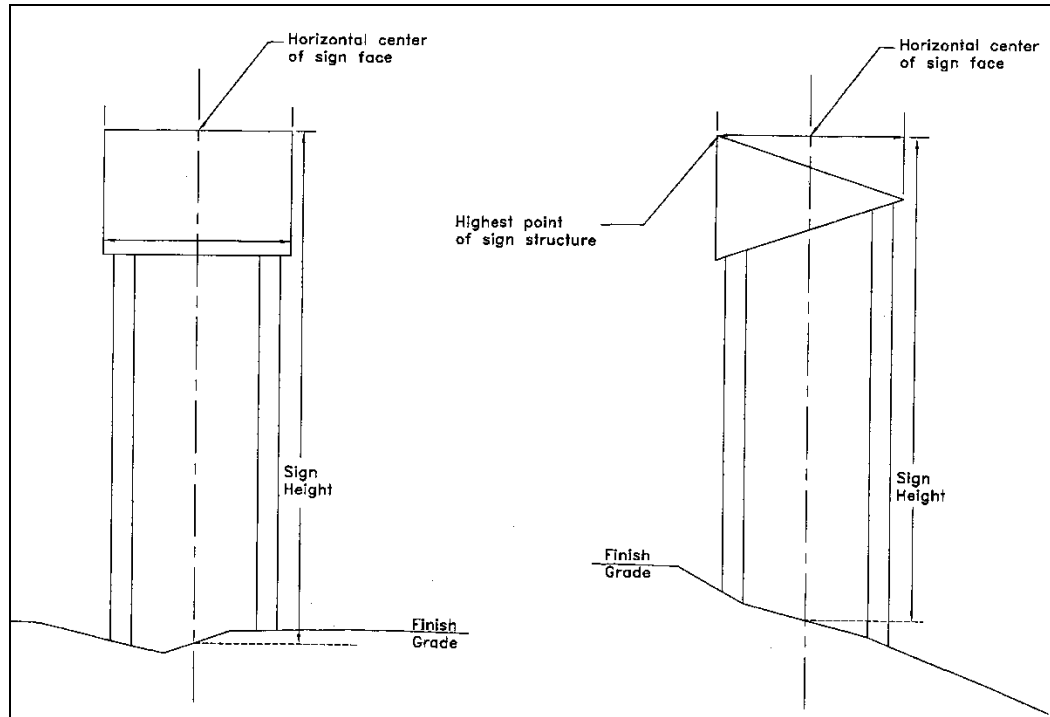

## 9.21.040 Permits Required

- A. Except as otherwise provided in this chapter, it shall be unlawful for any person to construct, alter or relocate a sign, or direct an employee or agent to do the same without first obtaining a permit for each separate sign from the City as required by this chapter.
- B. No sign permit shall be issued for an existing or proposed sign unless such sign conforms to the requirements of this Article.

## 9.21.041 Signs Exempt From Permits

The following signs are permitted and are exempt from permits. Other than the exemption from having to obtain a sign permit, the remaining applicable provisions of this ordinance and other applicable laws and ordinances shall apply. (Ord. 5424 §5, 2008; 5490 §3, 2009)

- A. Traffic Signs. Traffic signs and all other public safety, informational or directional signs erected or maintained by a municipal or governmental body or agency or public utility, including danger signs, railroad crossing signs and signs of a non-

Title 9 Last Revised 8.18.17



## City of Grants Pass Municipal Code

commercial nature required by public laws, ordinances or statutes.

- B. Holiday Decorations. Temporary decorations or displays topical to a state or federally recognized Holiday and erected not earlier than 30 days prior to said Holiday and removed not later than 4 days after said Holiday.
- C. Garage Sale Signs. Garage sale signs may be placed in accordance with Section 9.08.050 of the Municipal Code.
- D. Entrance Signs. One sign up to 2 square feet may be placed at the entrance to a building on any side of the building. Such a sign will not count against the total sign allocation for the business.
- E. Blade Signs. Blade signs must provide at least 8 feet of vertical clearance; one sign indicating the entrance to the premises is allowed per entrance; maximum size not to exceed 3 square feet.
- F. Real Estate Signs: Sale or Lease.
  - 1. One freestanding real estate sign is allowed per street frontage.
  - 2. Size: Up to 10 square feet in residential zones, including riders and flyer holders; up to 32 square feet in commercial and industrial zones.
  - 3. Height: Maximum height is 6 feet above grade.
  - 4. Off-premise real estate signs are not allowed.
- G. Real Estate Signs: Open Houses. Two “open house” signs are allowed per property, up to 6 square feet each. Signs must be removed daily. Off-premise signs are not allowed.
- H. Project Signs: Residential Zone.
  - 1. One construction project sign is allowed per street frontage on a lot being developed with a current development permit, up to 32 square feet each, up to a maximum of 3 signs.
  - 2. All signs shall be setback 10 feet from the property line and shall not exceed 10 feet in height.
  - 3. Illumination is prohibited.
  - 4. All signs must be removed within 30 days of the completion of the project or upon expiration of the development permit, whichever occurs first.

City of Grants Pass Municipal Code



- I. Project Signs: Industrial or Commercial Zone.
  - 1. One construction project sign is allowed per street frontage on a lot being developed with a current development permit, up to 64 square feet each, up to a maximum of 3 signs.
  - 2. One sign is allowed for each subcontractor up to 6 square feet.
  - 3. Section 9.21.041 (H) (2) through (4) shall also apply.
  
- J. Auction Signs.
  - 1. One auction sign up to 6 square feet is allowed per street frontage on the parcel where the auction is located.
  - 2. Off-premise direction signs up to 3 square feet each are allowed the day of the auction, outside of the public right of way.
  
- K. Signs on athletic fields and scoreboards intended for on-premises viewing.
  
- L. Projected Images: One image, up to 4 square feet per business, may be projected onto a sidewalk or other paved surface located on private property.
  
- M. Historic Advertising Art and Murals: If located on a landmark building or within a Historic District, the Historic Advertising or Mural requires review by the Historic Buildings and Sites Commission. (Ord. 16-5680 2016)
  
- N. Signs on a Truck, Bus, Car, Boat, Trailer or other motorized vehicle and equipment provided all the following conditions are adhered to:
  - 1. Primary purpose of such vehicle or equipment is not the display of signs.
  - 2. Signs are painted upon or applied directly to an integral part of the vehicle or equipment.
  - 3. Vehicle/equipment is in operating condition, currently registered and licensed to operate on public streets when applicable, and actively used in the daily function of a business/or use.
  - 4. Vehicles and equipment are not used as static displays, advertising a product or service, nor utilized as storage, shelter or distribution points for commercial products or services for the general public.
  
- O. Vehicles and Equipment engaged in active construction projects and the on premise storage of equipment and vehicles offered to the general public for rent or lease.



City of Grants Pass Municipal Code

- P. Indoor Signs. Signs located in the interior of any building or within an enclosed lobby or court of any group of buildings.
- Q. Drive-Up Window Menu Board Sign, Service Station Price Sign or Electronic / Manual Reader Board. Where an existing permitted Drive-Up Window Menu Board Sign, Service Station Price Sign or electronic / manual reader board is modified by change of message or design on the sign face without any change to size or shape of the sign framework or structure. Includes changing messages on permitted Changing Image Signs.
- R. Window Signs. Window signs located in windows, if they are mounted or painted upon the inside or outside of windows within all commercial or industrial zoning districts.
- S. Hand Carried Signs.
- T. Miscellaneous Signs. Any sign not legible from the public right of way.
- U. Directory Signs.
- V. Temporary Political Signs in compliance with the provisions of Section 9.21.610 – 650.
- W. Temporary Sign Displays. An attention attracting device or devices, including but not limited to, flags (non-governmental), pennants, streamers, lawn signs, balloons, inflatable objects, and air powered objects.

9.21.042 Application

Application for a permit shall be made to the City upon a form provided by the City and shall include the following:

- A. Two sets of drawings, including the following written information:
  - 1. Location of the sign on the building or building site.
  - 2. Dimensions of the sign.
  - 3. Construction materials.
  - 4. Method of attachment.
  - 5. Identity of the owner/lessee and installer of the sign.
  - 6. The state contractor 's registration number and Oregon electrical contractor 's number for electrical signs.

# City of Grants Pass Municipal Code

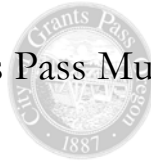

- B. Any supplemental information required to demonstrate compliance with applicable provisions of the Oregon Structural Specialty Code. (Ord. 5424 §5, 2008)

## 9.21.043 Issuance of Permits

- A. City personnel shall examine completed applications for permits within 5 working days after filing. If not accomplished within 5 days of completion, the application fee is waived. Note: Does not apply to denials. Does not apply to Section 9.21.400.
- B. If it appears from the application, drawings and specifications therewith that the requested sign(s) conform with all the provisions of this chapter, a permit shall be issued. But, if City personnel find that any requested sign(s) directly related to the application violate this chapter or any other chapter of the City code or ordinance related thereto, a permit shall not be issued until necessary corrections are made. (See 9.21.700 for exceptions.)
- C. No additional permits shall be issued for signs or businesses or uses with signs not already in compliance with this section, including overdue sign regulation fees or unpaid inspection charges.
- D. All signs, except for signs painted directly upon a building, are also subject to Building Department Requirements.
- E. Sign permits in the Historic District are subject to Historic District review.

## 9.21.044 Installation

- A. All companies installing electrical signs must have a current Oregon electrical contractor's license and will comply with all state and federal regulations pertaining to equipment and safety regulations.
- B. All electric signs must have an Underwriter Laboratories or other approved electrical underwriting service sticker and the sign manufacture's label. Note: It is illegal to remove or cover a manufacturer's label

# City of Grants Pass Municipal Code

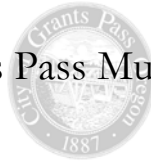

## 9.21.045 Permit Fee/No-Fee

- A. The fee for a sign permit shall be set by the City Council. Fees collected will be used to enforce and implement this code. The fee for any sign erected without a sign permit shall be double the regular sign fee.
- B. All signs, whether permanent or temporary, with a commercial message require a permit with a fee, unless exempt. (9.21.041) Note: A permitted sign removed from a building for maintenance or painting of the sign or building requires a no-fee permit to re-install the sign within 30 days of removal. A non-permitted sign must be brought into compliance within 30 days of removal and requires a permit.
- C. Any balloon/blimp in excess of 3 feet in diameter that is tethered over 10 feet above ground requires a no-fee permit, excluding hot air balloons.
- D. Banners require a no-fee permit.

## 9.21.046 Indemnification of City

As a condition to the issuance of a sign permit as required by this chapter, all persons engaged in the hanging or painting of signs, which involves, in whole or in part, the erection, alteration, relocation, maintenance or other sign work in, over or immediately adjacent to a public right of way or public property if used or encroached upon by the sign hanger or painter in the said sign work, shall agree to hold harmless and indemnify the City, its officers, agents and employees from liability for damages resulting from said erection, alteration, relocation, maintenance or other sign work.

## 9.21.047 Prohibited Signs

The following signs or devices are prohibited, and may neither be erected nor maintained: (Ord. 5424 §5, 2008; Ord. 5456 §2, 2008; Ord. 16-5680 2016)

- A. Traffic hazards: No sign shall be permitted at the intersection of a street or driveway in such a manner as to obstruct free and clear vision of motor vehicle operators or at any location where by reason of its position, shape or color it may interfere with or be confused with authorized traffic sign, signal or device, or which makes use of a word, symbol or phrase, shape or color in such a manner as to interfere with, mislead or confuse traffic. Refer to the Grants Pass Development Code for setback restrictions.
- B. Strobing lights or animated signs that resemble an emergency vehicle are prohibited and may not be displayed in any location visible from a public street, whether located inside or outside a building.
- C. Billboards.

## City of Grants Pass Municipal Code



### D. Signs on public property:

1. Except as set forth below or permitted elsewhere in this Chapter, no person shall paint, mark or write on, or post or otherwise affix in any manner, any hand-bill or sign to or upon any sidewalk, crosswalk, curb, curbstone, traffic sign, street lamp post, hydrant, public bench, tree, shrub, tree stake or guard, tree grate, railroad trestle, electric light, power, telephone or telegraph wire pole or wire appurtenant thereof, public art, ballot drop off box, bus shelter, utility vault, manhole cover, fire alarm, or upon any lighting system, public bridge, drinking fountain, statue, or fountain;
2. Any hand-bill or sign found posted or otherwise affixed upon any public or utility property contrary to the provisions of this section may be removed by any company, utility, organization, or individual owing or responsible for maintaining that property or any City employee. There shall be a rebuttable presumption that the person or organization whose name, telephone number or address appears as the person to contact on any hand-bill or sign posted is the person responsible for having posted the same. The person responsible for any such illegal posting shall be liable for the cost incurred in the removal thereof. The remedy is not exclusive of any other provisions allowed by law including being subject to the penalty provisions of Grants Pass Municipal Code 1.36.010.
3. The City reserves the right acting by resolution of the City Council to attach or affix in or on any public property metal plaques or plates or individual letters commemorating a historical, cultural, or artistic event, location or individual, flags, flower baskets, banners or public art.

#### 9.21.048 Abandoned Signs

- A. Any abandoned sign and supporting structure shall be removed by the owner of the sign or owner of the premises within 60 days following the date of abandonment.
- B. Any owner of an abandoned sign which is otherwise in conformance with this chapter may apply to the City for a 90 day extension of the removal date, upon proof of intent of occupancy within that period.

#### 9.21.050 Dangerous Signs

- A. Any dangerous or defective sign is hereby declared a nuisance and the owner/lessee has 48 hours after receiving notice to rectify the problem.
- B. Any sign which represents an immediate danger or imminent public safety hazard shall be rectified or removed at the direction of the City Manager.

#### 9.21.060 Signs in the General Commercial Zone

Title 9 Last Revised 8.18.17

# City of Grants Pass Municipal Code

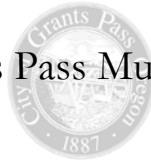

A. Freestanding Signs: Each parcel of land is permitted 1 freestanding sign per street frontage, subject to the following limitations:

1. Maximum height above grade: 25 feet. (Ord. 5424 §5, 2008)
2. Allowable square footage: 2 square feet per linear foot of street frontage up to 50 square feet, then 1 square feet per linear foot of street frontage thereafter.
3. Maximum allowable: 100 square feet. (Ord. 5424 §5, 2008)
4. Minimum allowable: up to at least 60 square feet regardless of street frontage.
5. Freestanding signs in a pedestrian area must not extend below 8 feet above the ground/surface.
6. Freestanding signs in a vehicular traffic area must provide at least 14.6 feet of clearance above the ground/surface.
7. Freestanding signs must be out of the visual clearance areas at driveways and intersections.
8. No part of a freestanding sign may project over a property line. (Ord. 5424 §5, 2008)
9. Permanent accessory equipment, including (but not limited to) catwalks and ladders, may not be attached to any portion of a freestanding sign structure. Structural elements shall be limited to those necessary to support the sign. (Ord. 5424 §5, 2008)
10. Any freestanding sign located within, or projecting over, a City Utility Easement (CUE) or potential future CUE shall be subject to the provisions of Section 9.21.130 (Freestanding Signs Within a City Utility Easement.) (Ord. 5424 §5, 2008)

B. Wall Signs / Projecting Signs: Wall signs and projecting signs are permitted subject to the following requirements:



# City of Grants Pass Municipal Code



1. **Alternate Determination of Maximum Sign Area:** Total sign area for wall and projecting signs shall be based upon the primary building frontage or the number of separately taxed businesses located on the same lot, whichever is greater. In no circumstances shall the sign area exceed this determination.
2. **Number of Signs:** There is no limit as to the number of wall or projecting signs so long as they are within the aggregate area limitations noted herein.
3. **Calculation Based Upon Separate Businesses:** Subject to subsection (6) below regarding Calculations for Conflict, each business is allowed up to 80 square feet of sign area for wall or projecting signs. Said sign allotment may be placed on any side wall of a building in which the business is located, subject to the permission of the owner or lessee.
4. **Primary Building Frontage:** The owner or lessee of a building will select the primary building frontage to be used by the City in determining allowable square footage for wall and projecting signs. Building frontage shall be based upon the side of a building which is capable of displaying advertising visible by the public from a public street.
5. **Calculation Based Upon Frontage:**
  - a. **Primary Building Frontage Side Allowance** is 2 square feet per linear foot of frontage up to a maximum of 200 square feet. Such allowance is not transferable to any other side.
  - b. **Each Non-Primary Building Side** shall receive an additional allowance equal to 50% of the Primary Building Frontage Side Allowance. Such allowance is not transferable to any other side.
6. **Calculations for Conflicts:** If because of existing signage, the addition of the minimum 80 square feet of signage for a business would result in any side exceeding the maximum amount noted in subsection (1) above, then the minimum will be reduced to conform to the maximum allowable sign area.
7. **Clearance:** Wall and projecting signs must be out of the visual clearance areas at driveways and intersections.
8. **Awning and Canopy Marquees:** Awning and canopy marquees may incorporate signs and may project over the right-of-way up to 3 feet. The sign shall be assessed against the aggregate for wall signs.



City of Grants Pass Municipal Code

9. Any attached sign, awning or canopy marquee which projects into the airspace above a City Utility Easement that interferes with the installation, maintenance, access or operation of a public utility may be removed by the utility at the sole cost of the utility. Any replacement or relocation of the sign shall be at the sole cost of the owner or occupant. (Ord. 5424 §5, 2008)

9.21.070 Signs in a Freeway Overlay Zone

(Deleted in its entirety by Ord. 5325, 2005)

9.21.080 Signs in a Neighborhood Commercial Zone

- A. Freestanding Signs: Each parcel of land is permitted 1 freestanding sign subject to the following limitations:

1. Maximum height above grade: 25 feet. (Ord. 5424 §5, 2008)
2. Allowable square footage: .5 square feet per linear foot of street frontage.
3. Maximum allowable: 60 square feet.
4. Minimum allowable up to 40 square feet.
5. Section 9.21.060 (A) (Freestanding Signs) (5) through (10) apply. (Ord. 5424 §5, 2008)

- B. Wall and Projecting Signs are permitted with the following limitations:

1. Primary Building Frontage: The business owner/lessee will determine the primary building frontage of the business. The aggregate area of all wall and projecting signs on the primary building frontage will not exceed 1 square feet per linear foot of primary building frontage. Maximum allowable - 80 square feet.
2. Each business is allowed up to at least 40 square feet aggregate, regardless of primary building frontage size.
3. Up to 1/2 of the allowable square footage of the primary building frontage may be used for wall and projecting sign on any other side or sides of the building.

9.21.090 Signs in Residential Zones

(Ord. 17-5718, 2017)

- A. Offices and Apartments in a Residential Zone.

1. One freestanding and one attached sign, not to exceed 32 square feet



City of Grants Pass Municipal Code

and 5 feet in height. (Ord. 16-5680 2016)

2. Signs may not be internally illuminated.

B. Real Estate Signs: Housing Development/Subdivision:

1. One real estate sign is allowed at each entrance or frontage road.
2. Size: Up to 32 square feet each.
3. Flags are allowed on flag poles not exceeding 30 feet above the ground.
4. Temporary signs must comply with Section 9.21.500 (E) of this code.
5. Off-premise real estate signs are not allowed.

9.21.100 Signs for a Shopping Center

A. Freestanding Signs:

1. Maximum height above grade: 25 feet except as noted below. (Ord. 4997 §1, 2000) (Ord. 5424 §5, 2008)
2. Allowable square footage: 1 square foot per linear foot of street frontage with no single freestanding sign exceeding 400 square feet. (Ord. 4997 §1, 2000)
3. Number of signs: No more than one 400 square foot freestanding sign per street frontage with entrance access and placed on said frontage. Notwithstanding said placement restriction, 2 frontage signs may be located on a single entrance frontage if the following are applied: (Ord. 4997 §1, 2000)
  - a. The allowable size of the first freestanding sign is reduced to 50% of the allowable square footage up to a maximum of 200 square feet; and (Ord. 4997 §1, 2000)

The allowable size of the second freestanding sign is reduced to a maximum of 50 square feet. (Ord. 4997 1, 2000)
  - b. The second freestanding sign is of monument construction and has an overall height of less than 7 feet from grade, inclusive of any construction or supporting structure used to support, suspend, or accentuate said sign. (Ord. 4997 1, 2000)
  - c. The two freestanding signs are located not less than 50 feet from one



# City of Grants Pass Municipal Code

another. (Ord. 4997 §1, 2000)

- d. The two freestanding signs are located not less than 25 feet from all adjoining property lines except public right-of way lines. (Ord. 4997 §1, 2000)
  - e. A deed restriction is placed on the property in favor of the City of Grants Pass, acknowledging any subsequent land division or change in use which results in loss of the shopping center status for the lot on which the signs are located will require immediate removal of both freestanding shopping center signs. (Ord. 4997 §1, 2000)
4. Directional signs will not exceed 3 square feet in size and will not count against total signage allotment. No more than two directional signs per entrance or exit. (Ord. 4997 §1, 2000)
  5. One lighted entrance sign is allowed up to 40 square feet per street frontage. The entrance sign must be out of the visual clearance areas at driveways and intersections. (Ord. 4997 §1, 2000)
  6. Section 9.21.060 (A) (Freestanding Signs) (5) through (10) apply. (Ord. 5424 §5, 2008)

B. Wall and Projecting Signs: The square footage for wall and projecting signs is same as allowed in the General Commercial Zone. Section 9.21.060 (B) (Wall Signs / Projecting Signs) (1) through (9) apply.

## 9.21.110 Signs in Industrial Zones

A. Freestanding Signs:

1. Maximum height: 25 feet. (Ord. 5424 §5, 2008)
2. Maximum square footage: 150 square feet per freestanding sign. (Ord. 5424 §5, 2008)
3. Maximum number: No more than 1 freestanding sign shall be permitted per street frontage.
4. Section 9.21.060 (A) (Freestanding Signs) (5) through (10) apply. (Ord. 5424 §5, 2008)

B. Wall and Projecting Signs: The square footage for wall and projecting signs is same as allowed in the General Commercial Zone. Section 9.21.060 (B) (Wall Signs / Projecting Signs) (1) through (9) apply.

C. Medical Park Overlay: In addition to 9.21.110, no more than 2 directional signs



## City of Grants Pass Municipal Code

allowed per entrance or exit. Signs shall not exceed 3 square feet in size and will not count against total signage allotment.

- D. Business Park Overlay: Same as Medical Park Overlay.

### 9.21.120 Signs in the Central Business District (CBD)

- A. Freestanding: Each parcel of land is permitted 1 freestanding sign per street frontage. Limitations for freestanding signs are the same as those in the General Commercial Zone. Section 9.21.060 (A) (Freestanding Signs) (1) through (10) apply. (Ord. 5424 §5, 2008)
- B. Wall Signs and Projecting Signs: The square footage for wall and projecting signs is the same as allowed in the General Commercial Zone. Section 9.21.060 (B) (Wall Signs) (1) through (7) apply.
- C. Awning and Canopy Marquees in Central Business District: Awning and canopy marquees in the Central Business District may incorporate signs and may project over the right-of-way to within 2 feet of the outer edge of the curb. The sign shall be assessed against the aggregate for wall signs.
- D. A-Frame/Sandwich Board/Sign on Wheels (Ord. 5408 §20, 2007)
1. One additional A-Frame/Sandwich Board/Sign on Wheels not to exceed 8 square feet in area per side for each business entrance is allowed. The edges of each sign face shall not be more than 36-inches apart. The sign may not be lighted or powered by any means.
  2. The sign may be located within the public right of way if placed directly in front of the business displaying the sign.
    - a. The sign must be placed to allow a minimum of 4 feet of clearance on the sidewalk.
    - b. In no case may the sign be displayed when a business is closed.
  3. A-Frame/Sandwich Board/Sign on Wheels as noted in 1 and 2 above are permitted for businesses located outside of the CBD when the building has a zero lot line setback at the street right of way or sidewalk.

### 9.21.121 Signs in the Historic District

The downtown Central Business District is recognized as the heart of the community and is valued for its historical, cultural, and economic significance. Signs are important tools for business owners and customers visiting the downtown area. This section of code is created to ensure the look and appearance of proposed signs is compatible with the façade of the buildings within the District and to promote the overall feel of the downtown core to ensure its longevity into the future.

## City of Grants Pass Municipal Code



- A. The Historical Buildings and Sites Commission shall have the authority to review sign applications for existing and new structures located within the Historic District pursuant to Schedule 13-2 of the Development Code. Appeals of decisions made by the Commission shall be appealed to the City Council. (Ord. 17-5718 7/19/17)
- B. Size & Placement: The allowable size of the proposed sign shall be in accordance with Municipal Code Section 9.21.120. Signs shall be sized and installed in appropriate sign areas along the façade, sides or rear of the building.
- C. Materials: Sign materials shall be consistent with the traditional character of the building within the Historic District.
- D. Color Palette: The colors proposed shall be those listed on the Historic Colors of America color palette. Other colors (such as bright or neon colors) will be considered at the discretion of the Commission.
- E. Illumination: Signs may be illuminated or non-illuminated. Illuminated signage shall use lighting forms consistent with the traditional character of the District. (Ord. 16-5680 2016)
- F. Shape & Relief: Signage in the Historic District is encouraged to be molded into complex shapes rather than plain rectangles, circles, or squares. Carvings, layers, and multiple forms are encouraged to provide dimension and depth to signs.
- G. Banner Signs:
  - 1. Banner signs may be permitted in the Historic District provided they meet the criteria listed in Section 9.21.500(D).
  - 2. Banner signs may be installed in the Historic District for a maximum of 30 days, or the duration of the particular season or event, whichever is less. Events are grand openings, special sales, or other holiday or seasonal events.
  - 3. Notwithstanding the provisions of Section 9.21.500(D), banner signs in the Historic District shall be permitted for a maximum period of one month. All other provisions of Section 9.21.500(D) shall apply regarding banner signs. This time period does not extend to signage placed on light posts in the right-of-way for non-advertising, decorative purposes.
- H. Prohibited Signs:
  - 1. Light Emitting Diode (LED) Changing Image Signs (note: LEDs are permissible when used as a light source behind back-lit opaque, or non-translucent, signage)



## City of Grants Pass Municipal Code

2. Box internally illuminated signs
3. Inflatable, fan-driven, or other similar signs or structures.

### 9.21.122 Downtown Mall Sign

One additional sign is allowed for each pedestrian entrance for a downtown mall. The additional signs shall be placed on the wall adjacent to the pedestrian entrance and shall be a maximum of one square foot per business of the downtown mall.

### 9.21.130 Freestanding Signs Within a City Utility Easement (Ord. 5424 §5, 2008)

No freestanding sign shall be located within, or project over, any existing City Utility Easement (CUE) or potential future CUE (within 10 feet of any existing public street right-of-way) unless constructed in accordance with the following provisions:

- A. Maximum height above grade: 8 feet.
- B. Maximum allowable square footage: 32 square feet regardless of street frontage.
- C. No freestanding sign may project over the public right-of-way.
- D. Changing Image Signs are not permitted within a CUE.
- E. A freestanding sign constructed within a CUE shall count towards the maximum allotment for freestanding signage for that particular street frontage.
- F. Any freestanding sign located within a CUE that interferes with the installation, maintenance, access or operation of a public utility may be removed by the utility at the sole cost of the utility. Any replacement or relocation of the sign shall be at the sole cost of the owner or occupant.
- G. Any freestanding sign constructed in accordance with these standards, or in accordance with more restrictive standards where they apply (such as for an office in a residential zone), shall be permitted within a CUE.

### 9.21.300 Signs for a Fairgrounds

- A. Freestanding: The limitations for Fairgrounds will be the same as the limitations for freestanding signs for a Shopping Center. See Section 9.21.100 (A) (Freestanding Signs).
- B. Wall Signs and Projecting Signs: The square footage for wall and projecting signs is same as allowed in the General Commercial Zone. Section 9.21.060 (B) (Wall Signs) (1) through (9) apply.

### 9.21.400 Signs for Regional Hospitals, Schools, and All Sports Parks.



## City of Grants Pass Municipal Code

Based upon the health, safety, and welfare of citizens in accessing major government and quasi government facilities and due to the unique nature of these types of facilities, signs for public schools, municipal all sports parks and regional hospitals may exceed the dimensional and numerical standards of this code, subject to the approval procedure set forth herein. Approval shall be at the discretion of the City Council and shall be based upon review of an integrated sign program for the entire facility to ensure sign distribution is adequate to facilitate proper identification of distinct activities.

### 9.21.500 Special Signs for all Commercial and Industrial Zones

(Ord. 4929 §1, 1998; Ord. 5129 §1, 2002; Ord. 5408 §20, 2007; Ord. 5424 §5, 2008; (Ord. 16-5680 2016))

- A. A-Frame/Sandwich Board/Sign on wheels, which are located outside the Central Business District and where the building on the property does not have a zero lot line setback from the street right of way or sidewalk. (see Municipal Code section 9.21.120):
1. A-Frame/Sandwich Board/Sign on Wheels not to exceed 12-square feet in area per side for each business entrance is allowed. The edges of each sign face shall not be more than 38 inches apart. Business entrance is defined as either the door into the business or the area adjacent to a driveway serving the business.
  2. Signs shall not be located within the public right of way except:
    - a. During a community event sponsored or officially sanctioned by the City; or
    - b. On weekends; or
    - c. After 6:00 p.m. on weekdays.
  3. The sign must be placed to allow a minimum of 4 feet of clearance on the sidewalk.
  4. Signs displayed in a front yard or exterior yard setback area or near a driveway may remain when a business is closed.
  5. Signs displayed on a sidewalk or in a planter strip in accordance with A.2. above (the area in between the curb and a sidewalk) shall be removed when a business is closed.
- B. Second-Story/Basement Business Signs:
- a. Second-story and basement enterprises or uses, which are maintained exclusively on a floor other than that on the street floor, shall be allowed a wall sign up to 50% of the ground level allotment. See Section 9.21.060 (B).



# City of Grants Pass Municipal Code



- b. Minimum allowed per business is up to 30 square feet.
- C. Service Station Price Signs: Price pod signs and similar signs which are used solely to advertise the price of vehicle fuel and which do not exceed 32 square feet will not count against total sign area or number allotment. Any size in excess shall be counted against sign allotment.
- D. Drive-Up Window Signs: One freestanding sign not to exceed 32 square feet in area for any single parcel of land occupied by a drive-up window business. Such signs shall not project into the public right-of-way and will not count against total signage allotment.
- E. Banners (Attached to a building and/or Displayed on the property)
  - 1. One temporary sign up to 40 square feet is allowed per building side.
  - 2. Where multiple businesses are connected to each by common walls; one (1) banner up to forty (40) square feet is allowed per business.
  - 3. No more than two (2) banners not attached to a building are permitted per street frontage.
  - 4. Display period is limited to 6 months. A no-fee permit is required.
  - 5. Banners may be installed on temporary man-made structures such as posts or fences; however in no case shall banners be attached to trees or public utility poles.
- F. Secondary Outdoor Business on Lot: A secondary outdoor business may have one sign up to 12 square feet and 8 feet in height. The sign must be attached to the cart or structure and be located outside the building setback area.
- G. Use of an Undeveloped Lot in a Commercial or Industrial Subdivision: One freestanding sign may be erected on an undeveloped lot in a commercial or industrial subdivision for the purpose of directing attention to a business, commodity, service, entertainment or attraction sold, offered, existing or planned either on the lot where the sign is displayed or elsewhere within the subdivision, provided that all of the following conditions are met: (Ord. 4974 §1, 1999)
  - 1. The sign is located on an undeveloped lot of land in a commercial or industrial subdivision with a minimum of 5 lots within the subdivision; and (Ord. 4974 §1, 1999)
  - 2. Only one such sign is permitted per subdivision; and (Ord. 4974 §1, 1999)



## City of Grants Pass Municipal Code

3. The size of the sign is subject to the provisions of Section 9.21.060 (A) Signs in the General Commercial Zone or Section 9.21.110 (A) Signs in Industrial Zones, depending on the zoning of the property; and (Ord. 4974 §1, 1999)
  4. If the lot on which the sign is proposed to be located has more than one street frontage, the sign shall front the street with either the higher functional classification or the higher number of daily traffic counts; and (Ord. 4974 §1, 1999)
  5. When the lot is developed, the existing sign will be credited against the current limits for both size and number of signs on a developed lot. (Ord. 4974 §1, 1999)
- H. Temporary decorations over 40 square feet in size, which qualify as a sign and which are lit with electrical bulbs or tubes, may be erected beginning November 1 of each year so long as they are removed by the following January 31. (Ord. 5019 §1, 2000)

Said signs may not be electrically lit until the day after Thanksgiving and shall not remain lit after January 7 of the following year. (Ord. 5019 §1, 2000)

Words, logos, and corporate symbols which could be reasonably construed as commercial advertising shall consist of not more than 10% of the overall size of the sign (decoration). (Ord. 5019 §1, 2000)

Such signs shall be subject to the review and approval of not less than two members of a three member panel of citizens appointed by the Council. A denial by the panel may be appealed to the Council if the appeal is filed in writing not less than one week from the date of the denial by the panel. (Ord. 5019 §1, 2000)

### 9.21.600 Temporary Political Signs

This section was combined with Section 9.21.090 (Ord. 17-5718 7/19/17)

### 9.21.610 Temporary Political Signs Defined (Ord. 4929 §1, 1998, Ord. 17-5709, 2107)

A temporary political sign is a rigid or flexible material used to advertise a candidate or ballot measure.

- A. Temporary Political Yard Signs are those signs which are 3 square feet or less with individual support.
- B. Temporary Political Oversized Signs are those signs exceeding 3 square feet.

### 9.21.620 General Placement Rules for all Temporary Political Signs (Ord. 5248, 2004, Ord. 17-5709. 2017)



City of Grants Pass Municipal Code

- A. Temporary political signs must be placed behind any sidewalk and cannot extend on or over public property or public right-of-way.
- B. Temporary political signs may be placed on vacant property.
- C. A “double sided” temporary political sign with no more than six inches of separation between each plane is considered a single sign.
- D. Temporary political signs may be erected no earlier than 11 weeks prior to the applicable election and must be removed no later than one week after the applicable election.

**9.21.630 Temporary Political Signs in Industrial and Commercial Zones**

(Ord. 4929 §1, 1998; Ord. 5129 §1, 2002, Ord. 17-5709, 2017)

- A. There is no limit to the number of temporary political yard signs which may be placed on property in the industrial or commercial zones.
- B. Oversized Political Signs in Commercial Zones: Each parcel of land is permitted 1 freestanding sign per street frontage, subject to the following limitations:
  - 1. Maximum height: 25 ft.
  - 2. Maximum square footage: 2 sq. ft. per linear foot of street frontage up to 50 sq. ft., then 1 sq. ft. per linear foot of street frontage thereafter.
  - 3. Maximum allowable sq. ft. is 100 sq. ft.
  - 4. Signs exceeding 6 ft. in height cannot be located within the front or exterior yard setback.

Note: Signs exceeding 6 ft. in height require a Building Permit.

- C. Oversized Political Signs in Industrial Zones: Each parcel of land is permitted 1 freestanding sign per street frontage, subject to the following limitations:
  - 1. Maximum height: 25 ft.
  - 2. Maximum square footage: 150 sq. ft. per freestanding sign.
  - 3. Signs exceeding 6 ft. in height cannot be located within the front or exterior yard setback.

Note: Signs exceeding 6 ft. in height require a Building Permit.

**9.21.640 Temporary Political Signs in Residential Zones**

(Ord. 4929 §1, 1998; Ord. 5129 §1, 2002, 17-5709, 2017)



## City of Grants Pass Municipal Code

There is no limit to the number of temporary political yard signs which may be placed on a single lot in a residential zone. If signs are attached to the same support, the overall area cannot exceed 3 square feet and 6 feet in height.

### 9.21.650 Enforcement

(Ord. 4929 §1, 1998; Ord. 5129 §1, 2002; Ord. 5455 §2, 2008, Ord. 17-5709, 2017)

- A. Candidates shall remove and City employees are authorized to remove and dispose of any sign which does not have a valid sign permit and which is located on or over public property or public right of way.
- B. Candidates shall remove and City employees are authorized to remove and dispose of any temporary political sign erected earlier than 11 weeks prior to the applicable election or not removed within one week after the applicable election.

### 9.21.700 Grandfather Clause

- A. All signs in service as of the date of the passage of this code with the exception of those signs which violate the setback area or are sight obscuring at intersections are allowed to remain.
- B. If any alterations are made after the adoption of this code, other than changes of face, a sign must be brought into compliance and permitted.
- C. Temporary signs, including banners, are not grandfathered and must meet the requirements of this code upon adoption. See Section 9.21.500 (E).

### 9.21.750 Heritage Markers

Notwithstanding any provision in the Municipal Code to the contrary, the following structures (herein referred to as Heritage Markers), which meet all of the following criteria, are permitted:

- A. After obtaining a sign permit (and an encroachment permit if located on public property), it has been built consistent with the character, dimensions, and materials noted in diagram “9.21.750-1” below (including a pitched roof, rough cut logs, shake or metal roof) and has been inspected and approved by the City Building Division. Said inspection shall include compliance with all of the provisions of section 9.21.750 through 9.21.760 in addition to all structural requirements of the Building Code;
- B. It describes one or more elements of the community’s history (over 50 years old), geography, geology, mapping, weather, wildlife, or vegetation. The information shall be permanently protected with a weather impervious material;

# City of Grants Pass Municipal Code



- C. It contains no personal or commercial advertising but may indicate the donor or sponsor of the Heritage Marker so long as the size of the printing of the name of the donor or sponsor is no greater than ¾ inch;
- D. It is not located in a residential zone;
- E. It is not located within public right of way; (Ord. 5490 §3, 2009)
- F. It is located a minimum of 15 feet from an intersection (measured from the back of sidewalk) and is located in such a manner that it does not create a vision hazard, as defined by the Grants Pass Development Code;
- G. If located within or projecting over a City Utility Easement, it is in conformance with Section 9.21.130 (Freestanding Signs Within a City Utility Easement) of this Code, including maximum height and size restrictions; (Ord. 5490 §3, 2009)
- H. Only one Heritage Marker may be placed on a single tax lot and it may not be placed in such a manner that it is in conflict with any Development Code requirements such as parking and landscaping; and
- I. At least 2 parking spaces are typically available to the general public and are located within 100 feet of the Heritage Marker, whether on private or public property (and shall not be required as additional parking). (Ord. 5393 §3, 2007)

DIAGRAM 9.21.750-1

9.21.750 - 1  
Specifications for Heritage Marker

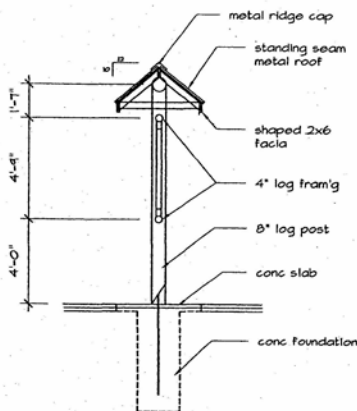

9.21.750 - 1  
Specifications for Heritage Marker

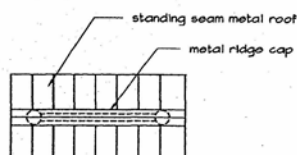
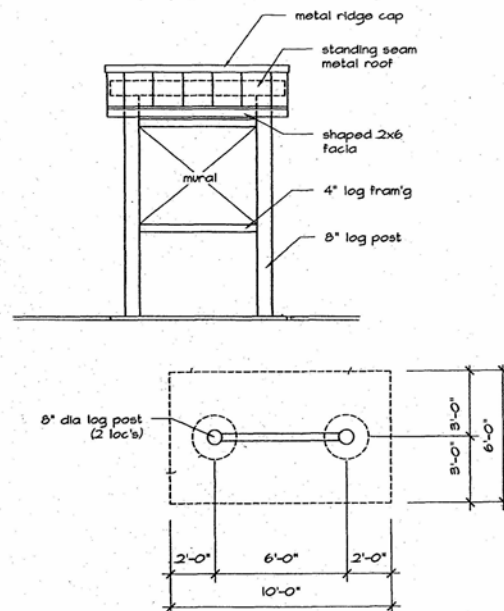



9.21.755 Heritage Markers Located on Private Property

If a Heritage Marker is located on private property, the property owner shall be responsible for maintaining it in excellent condition. If a Heritage Marker is not properly maintained, the City Manager shall so notify the property owner and allow 4 weeks for repair or replacement. If not properly repaired or replaced, the Heritage Marker shall be immediately removed upon the expiration of the 4 week period. Failure to remove shall be a violation of the Municipal Code for each day the Heritage Marker remains. (Ord. 5393 §3, 2007)

9.21.760 Heritage Markers Located on Public Property

If a Heritage Marker is located on public property that is not public right of way, placement must be approved by the City Manager; an encroachment permit must be obtained and complied with; and an agreement with the City (regarding placement, maintenance, liability, removal, etc.) must be executed by the Heritage Marker owner. If the agreement is breached, the City Manager shall so notify the owner(s) and allow 4 weeks to cure the breach. If not properly cured, the Heritage Marker shall be immediately removed upon the expiration of the 4-week period. Failure to remove shall be a violation of the Municipal Code for each day the Heritage Marker remains. (Ord. 5393 §3, 2007)

9.21.800 Appeals

- A. **PURPOSE:** The purpose of this section is to provide procedure and criteria to exceed measurable standards for signs including height, number and area.
- B. **APPLICABILITY:** This section applies only to applications for sign permits.
- C. **PROCEDURE:** The procedure for reviewing a request for a sign that involves an appeal shall require review before the City Council. If the lot has a Landmark Building or is located within the National Registry of Historic Places (Historic District), the appeal shall be reviewed by the Historic Buildings and Sites Commission. Their decision may be appealed to City Council.
- D. **CRITERIA:** No appeal shall be approved by the review body unless such appeal is shown to meet all of the following criteria:
  - 1. The appeal is required to alleviate unique physical circumstances or conditions, such as lot dimensions, topography, or other physical conditions or to enhance the historic significance of a building located within the Historic District.
  - 2. The appeal is the minimum increase required to prevent unnecessary hardship or to allow reasonable use of the property.



## City of Grants Pass Municipal Code

3. The proposal is not a substantial deviation from the standards outlined in this chapter and is consistent with the Purpose Section (9.21.010). The Review Body may require alterations to the sign or other signs on the property in order to provide a balanced exchange for the modifications being proposed. (Ord. 5514 §17, 2010)

# City of Grants Pass Municipal Code

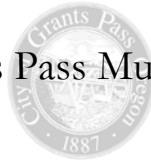

## Chapter 9.25

### Ballot Measure 37 Procedures

(Adopted by Ordinance No. 5264 on 12/1/04)

#### Sections:

9.25.100	Definitions
9.25.200	Claim Filing Procedures
9.25.300	Public Hearing
9.25.400	Valid Claims
9.25.500	Non-Conforming Use, Non-Conforming Lot
9.25.600	Fees and Costs



# City of Grants Pass Municipal Code



9.25.1100 Definitions As used in Chapter 9.25, the following definitions shall apply:

- A. City Manager means the City Manager or a designee.
- B. Claim means a demand for compensation or relief filed under Ballot Measure 37 that is accompanied by the required public notice fee, contains all of the information required by this Chapter, and is filed in accordance with this Chapter.
- C. Exempt land use regulation means a land use regulation that
  1. Restricts or prohibits activities commonly and historically recognized as public nuisances under common law; or
  2. Restricts or prohibits activities for the protection of public health and safety; or
  3. Is required to comply with federal law; or
  4. Restricts or prohibits the use of the subject property for the purpose of selling pornography or performing nude dancing; or
  5. Was enacted prior to the date of acquisition of the subject property by the owner or a family member of the owner who owned the subject property prior to acquisition or inheritance by the owner, whichever occurred first.
- D. Family member means the wife, husband, son, daughter, mother, father, brother, brother-in-law, sister, sister-in-law, son-in-law, daughter-in-law, mother-in-law, father-in-law, aunt, uncle, niece, nephew, stepparent, stepchild, grandparent, or grandchild of the owner of the subject property, an estate of any of the foregoing family members, or a legal entity continuously owned by any one or combination of these family members or the owner of the property.
- E. Land use regulation means a comprehensive plan, zoning ordinance, land division ordinance, transportation ordinance, ordinance that regulates the use of land (or any interest therein), or an ordinance that regulates farming or forest practices.
- F. Owner means a present owner of the subject property (or any interest therein) whose ownership interest has been continuous and uninterrupted.
- G. Officially waived means the date (after a public hearing is held and the City Council determines the claim is valid) that the subject property receives its tentative plat approval, or the date the subject property receives a certificate of occupancy, or the date the newly permitted use occurs on the subject property.



## City of Grants Pass Municipal Code

- H. Subject property means real property (or any interest therein) which is subject to the land use regulations of the City and which is the object of a claim under Ballot Measure 37.
- I. Valid claim means a claim submitted by a present owner of the subject property which the City Council has determined is subject to a land use regulation enacted or enforced by the City that restricts the use of the subject property and has the effect of reducing the fair market value of the subject property.

### 9.25.200 Claim Filing Procedures

A claim must be filed with the Director of the Community Development Department and must contain all of the following information:

- A. The names of all present owners of the subject property, together with their addresses, telephone numbers, and a description of their ownership interest in the subject property (including proof of their percentage of ownership), and the date they acquired their interest in the subject property, and if a claim is based on ownership by a family member, legal documentation showing the chain of title back to the original family member.
- B. The address, map and tax lot, and legal description of the subject property,
- C. A title report issued within 30 days of the filing of the claim that reflects all of the ownership interests in the property, together with documentation reflecting the claimant's ownership interest in the subject property.
- D. A copy of the citation or complaint issued by the City as an enforcement action, or a copy of the conditions of development (or denial of development) that form the basis for filing a claim under Ballot Measure 37.
- E. A copy of the land use regulations in existence, and applicable to the subject property, when the claimant became the owner of the subject property.
- F. A copy of the land use regulations the claimant asserts restricts the use of the subject property that has had the effect of reducing the fair market value of the subject property and the date such land use regulation (if adopted on or after December 2, 2004) was enacted or enforced, or the date such land use regulation (if adopted prior to December 2, 2004) was enforced.
- G. A narrative statement by the claimant describing how the enactment or enforcement of the land use regulation restricts the use of the subject property and has the effect of reducing the fair market value of the subject property, together with an explanation by the claimant of their understanding of what effect a modification, removal, or non-application of the land use regulation would have on the development of the subject property stating the greatest degree of



## City of Grants Pass Municipal Code

development that the owner believes would be permitted on the subject property if the identified land use regulations were modified or not applied.

- H. Copies of any easements, land purchase agreements, leases or Covenants, Conditions and Restrictions (CCRs), or other agreements or any private conditions applicable to the real property.
- I. A statement detailing the current fair market value of your subject property with the regulation challenged by the claimant; and a statement detailing what the fair market value of the property would be if the challenged regulation was not enforced; and the basis upon which the claimant arrived at their monetary figure including but not limited to copies of any appraisals, expert reports, and other information relied upon; together with a statement detailing the remedy sought. If an appraisal (prepared by an appraiser licensed by the State of Oregon to evaluate property of the class and type proposed per the standards set forth in this Chapter and Ballot Measure 37) is not included, the claim will be accepted, but a the staff evaluation and public hearing will not be scheduled until such an appraisal is received from the claimant.
- J. A statement from the claimant confirming that this claim consolidates all current and future potential claims for compensation under Ballot Measure 37 for reduction in fair market value of the subject property, based upon regulations in existence at the time of the claim for the claimant and for any successors in interest and for all other owners.

### 9.25.300 Public Hearing

- A. Not later than 120 days after the claim was filed and the claimant has provided a copy of an appraisal of the subject property from a appraiser (licensed to practice in the state of Oregon who evaluates the subject property per the standards set forth in this Chapter and Ballot Measure 37) the Community Development Director shall cause a staff report to be prepared analyzing the claim for the City Manager and the City Council which report shall be made available for inspection by the public prior to the public hearing noted herein.
- B. The City Manager may order an independent appraisal of the subject property to assist the Council in determining the validity of a claim.
- C. After receipt of the staff report and any appraisals, the City Manager shall schedule a public hearing before the City Council.
- D. The City Manager shall cause notices to be mailed to the owners of neighboring properties located within 250 feet of the perimeter of the subject property, advising them of the time and date of the public hearing.



## City of Grants Pass Municipal Code

- E. At the time and date previously scheduled, the City Council shall conduct a public hearing and provide an opportunity for staff, any owners of the subject property, owners of any neighboring properties, and members of the public to provide written or oral testimony (which may be limited at the sole discretion of the Council) before taking final action.
- F. Any appraisals and the Council's consideration of any reduction in market value shall include a consideration of the desires, interests, control, and character of ownership of the subject property by persons who are owners but not claimants.
- G. After the public testimony portion has been received, the Council may proceed with deliberations, or may adjourn its regular session and retire into executive session, or may continue the matter to a date certain for further deliberations.

### 9.25.400 Valid Claims

- A. Upon conclusion of the public hearing, and prior to the expiration of 180 days from the date the claim was filed, the City Council in public session shall:
  - 1. Determine that the claim does not meet the requirements of Ballot Measure 37 and of this ordinance, and deny the claim; or
  - 2. Direct the City Manager to prepare for litigation by the claimant; or
  - 3. Adopt a Resolution with findings therein that supports a determination that the claim is valid and do one or more of the following:
    - a. Direct that claimants who are owners of the subject property who were damaged by the application of land use regulations that were not in effect when their ownership interest was acquired be compensated in an amount set forth in the Resolution for all or a portion of the reduction in fair market value of the subject property proportional to their percentage of ownership of the subject property,
    - b. Modify the challenged land use regulation or any other land use regulation.
    - c. Direct that the challenged land use regulation or any other land use regulation not be applied to the subject property.
    - d. Direct the City Manager to negotiate for the purchase of the subject property.

## City of Grants Pass Municipal Code

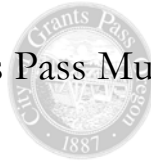

- e. Make a finding that the acquisition of the subject property (considering the waiver or value established by the Council through this process) is appropriate for any public or municipal use or for the general benefit and use of the people within or without the City, including but not limited to appropriation for a park, a City hall, City buildings, public parking, transportation facilities, right of way, City Utility Easement, and pedestrian facilities and authorize the City Manager to proceed with condemnation of all or a portion of the subject property or any interest therein if negotiations for the subject property are unsuccessful.
- B. The City Council's decision to compensate or to modify or not apply a land use regulation shall be based on how the public interest would be better served with due consideration for the interests of the public and neighboring properties in maintaining the current land use regulations and with due regard for the budgetary limitations of the City.
- C. The City Manager shall cause notices to be mailed to the owners of neighboring properties located within 250 feet of the perimeter of the subject property, advising them of the final decision.
- D. The City Manager shall cause the resolution of the Council to be filed with the County Clerk and recorded on the subject property indicating all Ballot Measure 37 compensation claims have been paid.

### 9.25.500 Non-Conforming Use, Non-Conforming Lot

- A. If the City Council decides not to apply or to modify the challenged land use regulation, it may, at its discretion, put back into effect with respect to the subject property, all or a portion of the land use regulations in effect at the time the claimant acquired the subject property.
- B. A person entitled to relief under this Chapter must be also be an owner at the time compensation is paid or an owner at the time any land use regulation is officially waived as defined herein.
- C. If the City Council decides not to apply or to modify the challenged land use regulation, then when the challenged regulation is officially waived herein, the property shall be considered a non-conforming use, non-conforming lot, or both and shall be treated as such under the Grants Pass Development Code and Municipal Code.
- D. If after an official waiver the property later applies for a further development permit, said application shall be governed by the land use regulations in effect at the time of the application.



## City of Grants Pass Municipal Code

- E. A decision to modify or not enforce a land use regulation is personal to the owner and may not be transferred to a person who is not a family member unless and until the date the land use regulation is officially waived as defined herein (i.e. the subject property receives its tentative plat approval, or the date the subject property receives a certificate of occupancy, or the date the newly permitted use occurs on the subject property).

### 9.25.600 Fees and Costs

- A. To cover the cost of the mailing of the hearing notice and notice of final decision to neighboring property owners and publishing the same, a person filing a claim under this Chapter shall pay a fee of \$500 at the time of filing to cover said expenses.
- B. In addition to the fee noted above, the claimant shall also pay a \$1,000 processing fee which shall be deferred until the final decision of the City and which shall be waived if the claim is determined by the City Council to be a valid claim.
- C. In addition to the fees noted above, if a claimant or potential claimant requests that the City conduct research relative to a claim under Ballot Measure 37, the claimant or potential claimant shall pay a research fee equivalent to the actual, fully loaded costs for staff time necessary to conduct said research and shall deposit \$200 with the Community Development Department for said costs. The City Manager shall maintain a record of the City's research costs (including staff time, copying, and legal costs). When said costs reach \$200 the City shall notify the claimant or potential claimant of the research findings to date and advise them that further research will require additional \$200 deposits which will be handled in the same manner as the initial deposit.



City of Grants Pass Municipal Code

Chapter 9.28

RECREATIONAL VEHICLES

Sections:

- 9.28.010 Recreational Vehicles Defined (Ord. 5349, 2006)
- 9.28.020 Use Restrictions
- 9.28.030 Permanent Residence
- 9.28.040 Sewer Connection
- 9.28.050 Exceptions



9.28.010 Recreational Vehicles Defined

A recreational vehicle as used in this chapter is defined as any unit for living or sleeping purposes which is equipped with wheels or similar devices for the purpose of transporting the recreational vehicle which is designed for placement on a vehicle equipped with wheels. This definition includes but is not limited to trailers, 5<sup>th</sup> wheels, motor homes, and campers). (Ord. 1348 §1, 1947, Ord. 5349, 2006).

9.28.020 Use Restrictions

A recreational vehicle currently used for sleeping or living purposes may only be parked:

- A. On a City street for up to 8 hours in the same parking space if said space is not restricted by other parking regulations; or
- B. In a City owned parking lot (with the permission of the City Manager) for up to 72 hours; or
- C. In a private parking lot (with the permission of the owner or operator of the private parking lot) for up to 24 hours within a 7 day period, for a parking lot with less than 100 spaces; or
- D. In a private parking lot (with the permission of the owner or operator of the private parking lot) for up to 72 hours within a 21 day period, for a parking lot with more than 99 parking spaces.
- E. On private property (with a residence, in a residential zone, and with the permission of the owner) for up to 72 hours within a 21-day period.
- F. 928.020 does not supersede the provisions of 6.03.035, 6.03.036, and 6.03.500. (Ord. 5349, 15, 2006).

9.28.030 Permanent Residence

Any recreational vehicle from which the wheels have been removed, except for the purpose of making temporary repairs or placing in dead storage, or any recreational vehicle from which the wheels have not been removed but which has been placed on permanent or temporary foundation of any kind is declared to be a permanent residence and such recreational vehicle shall meet all the requirements of the City relating to zoning, construction of a building and sanitation. (Ord. 1348 §3, 1947)



# City of Grants Pass Municipal Code

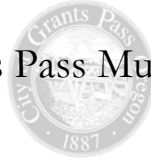

## 9.28.040 Sewer Connection

It is unlawful for any person occupying or using any recreational vehicle within the City to use any toilet, sink, lavatory or similar equipment therein unless and except the same be connected with the public sewer or to an approved septic tank in accordance with Chapter 8.16. (Ord. 1348 §4, 1947)

## 9.28.050 Exceptions

This chapter does not apply to the use of recreational vehicles, trailer houses, automobile trailers, campers or motor homes allowed Christmas tree lots or as living facilities for members of an established organization or group attending a convention or meeting thereof, as such might be permitted pursuant to any current zoning ordinance of the City. (Ord. 3984, 1974; Ord. 1348 §7, 1947)



# City of Grants Pass Municipal Code

This Chapter has been repealed in its entirety by Ord. 5267, 2005.

## Chapter 9.36

### PUBLIC IMPROVEMENTS

#### Sections:

- 9.36.010 Definition of Public Improvements
- 9.36.020 Receipt of Application
- 9.36.030 Resolution - Declaration of Intent
- 9.36.040 Resolution - Filing of Report
- 9.36.050 Resolution - Notice
- 9.36.060 Resolution - Notice - Contents
- 9.36.070 Remonstrance
- 9.36.080 Public Hearing
- 9.36.090 Assessment Ordinance
- 9.36.095 Method of Apportionment
- 9.36.100 Method of Assessment
- 9.36.110 Assessment Liens
- 9.36.120 City Construction
- 9.36.130 Deficit Assessment
- 9.36.140 Excess of Assessment
- 9.36.150 Validity of Assessments
- 9.36.160 Invalid Assessments
- 9.36.170 Multiple Public Improvements

# City of Grants Pass Municipal Code



## 9.36.010 Definition of Public Improvements

"Public Improvement" means and includes the term "Local Improvement" and further means the following:

- A. The grading, graveling, paving or other surfacing of any street, or opening, laying out, widening, extending, altering, changing the grade of or constructing any street;
- B. The construction or reconstruction of sidewalks;
- C. The reconstruction or repair of any street improvement mentioned in this section;
- D. The construction, reconstruction or repair of any sanitary or storm sewer or water main;
- E. The construction, reconstruction or repair of any flood control dike, dam, structure or facility;
- F. Those "local improvements" as provided in ORS 223.387 as now written or hereafter amended;
- G. Any other public improvement authorized by the Council.
- H. "Special Assessment" means a monetary obligation imposed by a municipality on real property within a designated area for the purpose of defraying all or part of the cost of a specific local improvement which benefits that real property. (Ord. 4139 §1, 1977; Ord. 4506 §1, 1984)

## 9.36.020 Receipt of Application

The Council will receive applications to make, alter, vacate or abandon one or more public improvements, which application shall be made by the Council or upon petition of all but no less than 33 percent of the owners of property to be specially benefited from any said improvement, and the application shall pertain to the funding of special public improvements, all or in part, at the expense of owners of benefited properties, and to be paid for, in whole or in part, by special assessment upon such property. (Ord. 4139 §2, 1977; Ord. 4482 §1, 1983)

## 9.36.030 Resolution - Declaration of Intent

When the Council approves the application it shall, by resolution or resolutions, declare its intention to proceed with the public improvement or improvements and hold a hearing thereon. (Ord. 4139 §3 (part), 1977)

# City of Grants Pass Municipal Code

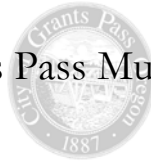

## 9.36.040 Resolution - Filing of Report

Any such resolution shall direct the City manager to have prepared and filed with the finance director a "Public Improvement Report" which shall, unless the Council otherwise directs, contain the following matters:

- A. Map or plat showing general nature, location and extent of the proposed public improvements and the land to be assessed for the payment of any part of the cost thereof;
- B. A general description and cost estimate of the work to be done provided that where the improvement project is to be carried out in cooperation with any other governmental agency, the description and cost estimates of such agency may be incorporated in the public improvement report;
- C. An estimate of the probable cost of the public improvement, including any legal, administrative and engineering costs attributable thereto;
- D. If applicable, an estimate of the unit of cost of the improvement to the specially benefited properties;
- E. A recommendation as to the method of assessment to be used to arrive at a fair apportionment of the whole or any portion of the cost of the improvement to the property specially benefited; and
- F. The description and assessed value of each lot, parcel of land or portion thereof, to be specially benefited by the improvement, with the names of the owners, and an owner meaning the record holder of the legal title or, where land is being purchased under a land sale contract, recorded, the purchaser shall be deemed the owner. (Ord. 4139 § (a), 1977)

## 9.36.050 Resolution - Notice

Any such resolution shall declare the Council's intention to make such proposed public improvements, provide the manner and method of carrying out the same, and direct the finance director to give notice of such proposed improvement and of the public hearing thereon by posting one copy of a notice thereof in the City's municipal building and not less than two copies thereof within the boundaries of the District where the proposed improvement is to be made. The notice shall first be posted not later than ten days prior to the hearing and shall contain not less than the following:

- A. Description of the project and its total estimated cost;
- B. Information that the public improvement report is on file in the office of the finance director and is subject to public examination;

## City of Grants Pass Municipal Code

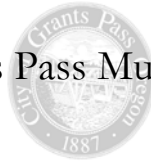

- C. The date when the Council shall hold a public hearing on the proposed public improvement, which hearing shall not be earlier than ten days following the first posting of the notice, and at which hearing objections and remonstrances to such proposed public improvements will be heard by the Council stating that if prior to such public hearing there shall be filed with the finance director valid written remonstrances filed by the owners of fifty-one percent of the property abutting on such public improvements, other than water or sanitary sewer, and computed on a lineal foot basis, then no such public improvements shall be made, but the Council may consider the same again not less than six months after the filing of such remonstrance, provided further that Council has the authority to install water or sanitary improvements over one hundred percent objections. (Ord. 4139 §3(b)(part), 1977; Ord. 4482 §2, 1983)

### 9.36.060 Resolution - Notice - Contents

In addition to the foregoing, the finance director shall mail a copy of such notice to the owner of the lot or tract proposed to be assessed, which notice shall be mailed not less than ten days prior to said public hearing, and which notice shall also include the following:

- A. The amount or amounts of the assessments proposed on that owner's property;
- B. The fact that Bancroft Bonding Act information is available at the finance director's office;
- C. Information that a remonstrance may be filed against such public improvement and the nature and effect of such remonstrance, including the fact that adequate remonstrance filed at the finance director's office prior to the public hearing will cause termination of the proposed public improvement, with the exceptions of water or sanitary sewer improvements;
- D. That remonstrance forms are available in the finance director's office; and also that if no remonstrance is filed by an owner, such owner will be considered in favor of the proposed public improvement.  
(Ord. 4139 §3(b)(part), 1977)

### 9.36.070 Remonstrance

- A. Any proposal to levy and collect public improvement assessments for improvement of streets (with associated curb and gutter) and storm lines or sidewalk in an area not designated as a Safety Zone shall be defeated if over 50% of the owners of property abutting on said street or alley to be so improved or repaired, (computed on a lineal foot basis) file a written remonstrance with the Administrative Services Director prior to or at the first



## City of Grants Pass Municipal Code

public hearing pertaining to public improvements or presents the remonstrance at the first public hearing. (Ord. 4980 §1, 1999; Ord. 5141 §1, 2002)

- B. Any proposal to levy and collect public improvement assessments for improvement of sidewalk (with associated curb and gutter) within a Council designated Safety Zone shall be defeated if sixty-seven percent of the owners of property abutting on said street to be so improved or required (computed on a lineal foot basis) file a written remonstrance with the Administrative Services Director prior to the first public hearing pertaining to public improvements or presents the remonstrance at the first public hearing. (Ord. 5141 §1, 2002)
- C. Such projects defeated by written remonstrances may be considered again by the Council not less than six months after the filing of such remonstrances. (Ord. 5141 §1, 2002)
- D. The Council shall have the authority to install water or sanitary sewer improvements over one hundred percent objections. (Ord. 5141 §1, 2002)
- E. "Owner", for the purposes of this chapter, shall mean the record owner of the legal title or, where land is being purchased under a land sale contract, recorded, the purchaser shall be deemed the owner. (Ord. 4139 §4, 1977; Ord. 4482 §3, 1983; Ord. 5141 §1, 2002)

### 9.36.080 Public Hearing

At the time of the public hearing on the proposed public improvement and the assessments, if written remonstrances shall represent less than the property required to defeat the proposal improvement, then, on the basis of said hearing and after consideration of the public improvement report, the council may by motion at the time of said hearing, or within sixty days thereafter, order such public improvement to be carried out, or the Council may decide not to carry out the public improvement. The Council may approve such public improvement report at the public hearing, or modify the report then or later. (Ord. 4139 §5, 1977)

### 9.36.090 Assessment Ordinance

- A. After any public hearing on the proposed public improvement and after the Council has moved to proceed with the improvement, it may pass an ordinance assessing the various lots, parcels of land, or parts thereof to be specifically benefited, with their apportioned share of the cost of the public improvement.
- B. At any time thereafter, such assessment may be apportioned where a special assessment is enjoined upon a single tract or parcel of real property among

Title 9 Last Revised 8.18.17



## City of Grants Pass Municipal Code

all the parcels formed from a subsequent partitioned or other division of the tract or parcel if:

1. The subsequent partition or division is in accordance with ORS 92.010 to 92.170.
2. It is consistent with all applicable comprehensive plans as acknowledged by the Land Conservation and Development Commission under ORS 197.251
3. Requested by any owner, mortgage or lien holder of a parcel of real property with a special assessment. Where the deed is unrecorded, the City shall not apportion the special assessment unless the applicant files a true copy of that deed, mortgage or instrument with the City.
4. Upon application, the parcel has been assigned a tax lot number. The applicant shall also furnish a tax lot number for the parent parcel.  
(Ord. 4039 §1, 1979; Ord. 4139 §6, 1977; Ord. 4506 §2, 1984)

### 9.36.095 Method of Apportionment

- A. The City shall apportion such special assessments by any method allowed in 9.36.100.
- B. Apportionment shall be done by resolution, which shall describe each parcel, the amount of the special assessment, the owner of the parcel, and such other information as is required to keep a permanent and complete record of the assessments and the payments therein.
- C. A copy of the resolution shall be filed with the finance director, who shall make any necessary changes or entries in the lien docket for the City.
- D. The City may establish a fee, set by resolution, for the costs of apportionment. Such costs shall reasonably be calculated to reimburse the City of its actual costs in apportioning special assessments. (Ord. 4506 §3, 1984)

### 9.36.100 Method of Assessment

The Council, in adopting a method of assessment of the cost of the public improvement may:

- A. Use any just and reasonable method of determining the extent of any improvement district consistent with the benefits derived.

## City of Grants Pass Municipal Code



- B. Use any method of apportioning the cost to be assessed as is just and reasonable between the properties determined to be specially benefited.
- C. Authorize payment by the City of all or any part of the cost of such public improvement when in the opinion of the Council the topographical or physical conditions or unusual factors involved in the proposed public improvement warrants only a partial payment or no payment by the benefited property of the costs of the public improvement
- D. Nothing contained in this chapter shall preclude the Council from using any other available means of financing improvements, including federal, state or county assistance in any form. In the event such other means of financing are used, the Council may in its discretion levy special assessments according to the benefits derived to cover any remaining costs of the public improvement. (Ord. 4139 §7, 1977)

### 9.36.110 Assessment Liens

- A. After the assessment ordinance has been passed by the Council, the finance director shall enter the assessment liens in the City docket.
- B. Such liens shall be due and payable thirty days from the date of the assessment ordinance unless the property owner, within said thirty-day period, files a valid application to pay the assessment in installments in accordance with the provisions of the Bancroft Bonding Act.
- C. The unpaid principal, being paid off under the provisions of the Bancroft Bonding Act, shall earn interest at a rate to be set by the assessment ordinance until the date of sale of improvement bonds relating to the specific public improvement district; thereafter, the interest shall accrue at a rate not to exceed the net effective interest rate of the said improvement bonds plus an administrative fee to be set by resolution.
- D. Any unpaid, delinquent lien may be foreclosed in the manner provided by the Oregon Revised Statutes. All such unpaid delinquent liens shall bear interest at the rate of ten percent per annum until paid by the owner or foreclosed by the City. (Ord. 4422 §1, 1981; Ord. 4346 §1, 1980; Ord. 4139 §8, 1977)

### 9.36.120 City Construction

The Council may provide that construction work may be done in whole or in part by the City, by a contract, or by any other governmental agency, or by any combination thereof. (Ord. 4139 §9, 1977)





9.36.130 Deficit Assessment

- A. In the event that an assessment shall be made before the total cost of the improvement is ascertained and if it is found that the amount of the assessment is insufficient to defray the expense of the improvement, the Council may by motion declare a deficit and order a proposed deficit assessment prepared.
- B. The Council shall set a time for hearing of objections to the deficit assessment and shall direct the finance director to mail a notice of such hearing to each owner of property on which the deficit assessment is proposed, which notice shall be mailed not less than ten days prior to the hearing.
- C. After such hearing the Council shall make a just and equitable deficiency assessment by ordinance which shall be entered in the City lien docket as provided by this ordinance. Such deficiency assessment shall be due and payable within thirty days of the deficiency assessment ordinance, unless application has been filed within the thirty day period for payment of the deficiency in installments under the provisions of the Bancroft Bonding Act. (Ord. 4139 §10, 1977)

9.36.140 Excess Assessment

If upon completion of the improvement project it is found that the assessment previously levied upon any property is more than sufficient to pay the cost of such improvement, then the Council must ascertain and declare the same by ordinance. When so declared, the exact amount shall be entered on the City lien docket as a credit upon the appropriate assessment. In the event that any assessment has been already paid, the person who paid the same, or his personal representative, heirs or successor, if a corporation, shall be entitled to repayment of such rebate credit, or the portion thereof which exceeds the amount unpaid on the original assessment. (Ord. 4139 §11, 1977)

9.36.150 Validity of Assessments

No improvement assessment shall be rendered invalid by reason of failure of the public improvement report to contain all information required by this chapter, or by reason of a failure to have all information required to be in any improvement resolution, assessment ordinance, lien docket, or notices required to be published, or mailed, or by the failure to list the name, or mail notice to the owner of any property as required by this chapter, or by reason of any other error, mistake, delay, omission, irregularity or other act, jurisdictional or otherwise, in any of the proceedings or steps specified in this chapter, unless it appears that the assessment is unfair or unjust in its effect upon the person complaining, and the



## City of Grants Pass Municipal Code

Council shall have the power and authority to remedy and correct all such matters by suitable action and proceedings, including but not limited to correction ordinances, resolutions, and the like. (Ord. 4139 §12, 1977)

### 9.36.160 Invalid Assessments

Whenever any assessment, deficit, or reassessment for any improvement which has been made by the City has been or shall be set aside, annulled, declared or rendered void, or its enforcement restrained by any court of this state, or any federal court having jurisdiction thereof, or when the Council shall be in doubt as to the validity of such assessment, deficit assessment or reassessment, or any part thereof, then the Council may make a reassessment in the manner provided by the laws of the state. (Ord. 4139 §13, 1977)

### 9.36.170 Multiple Public Improvements

More than one public improvement may be included in any application pertaining thereto, resolution, ordinance, public hearing, or the like, and any remonstrance or other action authorized by this chapter or any other ordinance of the City, or by state law, may be directed toward one or more such public improvements if the same are contained in a single application and set forth in a single notice and to be considered at a single public hearing. (Ord. 4139 §14, 1977)

# City of Grants Pass Municipal Code



Chapter 9.37 has been added by Ord. 4752 §1, 1992.  
Ord. 5517/Res. 5682 §6, 2010

## Chapter 9.37

### PREQUALIFICATION REQUIREMENTS

#### Sections:

- 9.37.010 Requirements
- 9.37.020 Disqualification and Restrictions
- 9.37.030 Hearing
- 9.37.040 Period of Disqualification or Restrictions
- 9.37.050 Restrictions
- 9.37.060 Appeal to City Manager
- 9.37.070 Appeal to City Council
- 9.37.080 Interim Effectiveness of Disqualification or Restriction

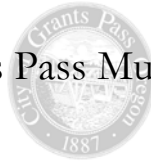

9.37.010 Requirements

To be prequalified to work on projects involving the construction of public facilities, a Contractor must meet the following requirements:

- B. Experience. The contractor or the contractor's supervisor on the project must have twelve months working as a contractor or supervisor on comparable public projects (e.g. monetary value, complexity) with the same materials as those required by City standards (i.e. ductile iron pipe for water lines), or comparable competence as determined by the City Manager.
- C. Inspection Substitution. These criteria can be substituted with a City approved schedule for inspection of the project by a licensed engineer with a civil or structural background. The costs of this additional inspection shall be the joint and several responsibilities of the contractor, supervisor and developer, not the City.
- D. Safety. The contractor or supervisor must have an OSHA approved, written safety program with proof of monthly safety meetings for the twelve months preceding a bid.
- E. Current Oregon Contractor License. The contractor shall have a current Oregon General Contractor's License.
- F. Current City Business License. The contractor shall have a current City Business License.
- G. Insurance Bonds. The contractor shall have adequate current insurance bonds to cover the contract amount (if no performance bond). Liability insurance requirements shall be set forth by resolution. (Ord. 5517/Res. 5682 §2, 2010)
- H. Workers' Compensation. All employees must be covered by Oregon Workers Compensation.
- I. On Site Supervision. A crew leader with at least twelve months experience must be on site during all work. This can be eliminated if the contractor or supervisor, who satisfies item 1, is on site during all work.
- J. Training Sessions. To qualify for prequalification, the contractor must agree to attend a City training program prior to the awarding of any bid. The training program will provide information on working on projects within the right-of-way and review City standards and requirements.

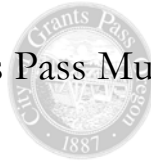

- K. Construction and Safety Standards. The contractor shall continually abide by the terms of the contract, the City approved construction drawings, and standard City specifications for installation of all public facilities within the jurisdiction of the City of Grants Pass. The contractor has the obligation to be familiar with and comply with all applicable City, state, and federal construction and safety standards, and applicable laws. Ignorance of these standards or laws is not an excuse for non-compliance.

#### 9.37.020 Disqualification and Restrictions

A contractor may be disqualified or restricted from working on projects involving the construction of public facilities if it is found that the contractor, or any agent or employee, fails to meet, or has misrepresented the contractor's compliance with, the City's prequalification requirements.

#### 9.37.030 Hearing

When a contractor is alleged to be in violation or non-compliance with any of the prequalification requirements, a hearing will be held by the Community Development Director, or a designee, as hearings officer to review the violation or non-compliance. A notice of the hearing and a brief statement of the allegation shall be mailed to the last known address of the contractor not less than seven days prior to the hearing. At the hearing the hearings officer, shall provide an opportunity for the contractor to be advised of the basis for the allegation and to provide evidence to refute or mitigate the allegation. The hearings officer shall make a decision within five days of the hearing and shall cause the decision to be mailed to the last known address of the contractor within four days of the decision.

#### 9.37.040 Period of Disqualification or Restrictions

A contractor found in violation or non-compliance shall be disqualified or restricted by the hearings officer regarding the construction of public facilities for a specified period of time based upon the seriousness of the violation or non-compliance. Disqualification or restrictions imposed for a first offense shall be not longer than twelve months. Subsequent disqualifications or restrictions may exceed twelve months but shall not exceed twenty-four months. A period of disqualification may be followed by a period of restrictions so long as the total period does not exceed the above stated time limitations.

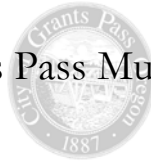

9.37.050 Restrictions

When the hearings officer determines that a violation or non-compliance with the City's prequalification requirements should result in restrictions instead of disqualification, the hearings officer shall state the reasons for mitigation in the decision. A restriction may include the imposition of additional conditions and requirements including but not limited to providing a civil or structural engineer to provide full time inspections of construction, said costs being the responsibility of the contractor.

9.37.060 Appeal to City Manager

A decision by the hearings officer to disqualify or restrict a contractor may be appealed to the City Manager by filing a written notice of appeal within fourteen days of the decision by the hearings officer. The City Manager shall conduct a hearing within thirty days of the notice to appeal. A notice of the hearing shall be mailed to the last known address of the contractor not less than seven days prior to the hearing. At the hearing the City Manager shall provide an opportunity for the contractor to challenge the disqualification or imposition of restrictions. The City Manager shall make a decision within 5 days of the hearing and shall cause the decision to be mailed to the last known address of the contractor within four days of the decision. The City Manager may affirm, reverse, or modify the decision of the hearings officer.

The decision of the City Manager shall comply with the PERIOD OF DISQUALIFICATION OR RESTRICTIONS and RESTRICTIONS provisions noted above. Modification of the hearings officers' decision may include but is not limited to:

1. Increasing or decreasing the quantity or quality of restrictions imposed.
2. Changing a disqualification to a restriction.
3. Changing a restriction to a disqualification.

9.37.070 Appeal to City Council

A decision by the City Manager to disqualify or restrict a contractor may be appealed to the City Council by filing a written notice of appeal within 14 days of the decision by the City Manager. The City Council shall conduct a hearing within 30 days of the notice to appeal. A notice of the hearing shall be mailed to the last known address of the contractor not less than 7 days prior to the hearing.

At the hearing the City Council shall provide an opportunity for the contractor to challenge the disqualification or imposition of restrictions. The City Council shall make a decision within 14 days of the hearing and shall cause the decision to be mailed to the last known address of the contractor within 4 days of the decision.



## City of Grants Pass Municipal Code

The City Council may affirm, reverse, or modify the decision of the City Manager. The decision of the City Council shall comply with the PERIOD OF DISQUALIFICATION OR RESTRICTION and RESTRICTIONS, provisions noted above. Modification of the Manager's decision may include but is not limited to:

1. Increasing or decreasing the quantity or quality of restrictions imposed.
2. Changing a disqualification to a restriction.
3. Changing a restriction to a disqualification.

### 9.37.080 Interim Effectiveness of Disqualification or Restriction

A decision of the hearings officer shall be effective immediately and shall remain effective unless or until it is affirmed, reversed, or modified by the City Manager. A decision of the City Manager shall be effective immediately and shall remain effective unless or until it is affirmed, reversed, or modified by the City Council.

City of Grants Pass Municipal Code



Chapter 9.40

REIMBURSEMENT DISTRICTS FOR PUBLIC IMPROVEMENTS

Sections:

- 9.40.005 Determination of Council Action
- 9.40.010 Definitions
- 9.40.020 Receipt of Application
- 9.40.030 City Manager Analysis
- 9.40.040 Public Hearing - Notification
- 9.40.050 Public Hearing
- 9.40.060 Reimbursement District Ordinance
- 9.40.070 Reimbursement District Final Ordinances
- 9.40.080 Reimbursement District Agreement
- 9.40.090 Notice of Decision
- 9.40.100 Imposition of Reimbursement Requirement
- 9.40.110 Calculation of Reimbursement - Intervening Properties
- 9.40.120 Construction Index Applied to Reimbursements
- 9.40.130 Collection of Reimbursement District Funds
- 9.40.140 Voluntary Imposition of Lien
- 9.40.150 Disposition of Reimbursements
- 9.40.160 Recording
- 9.40.170 Public Improvements



# City of Grants Pass Municipal Code



## 9.40.005 Determination of Council Action

Reimbursement District for Public Improvements prescribed in this chapter provides for the financial recapture for the original installer of public facilities. The creation of a Reimbursement District as prescribed herein is a legislative action of the City Council and is not subject to Land Use regulations or determination procedures. (Ord. 5140 §1, 2002)

## 9.40.010 Definitions

The following words and phrases for the purposes of this chapter and for the purposes of any reimbursement agreement entered into pursuant hereto and for any actions taken as authorized pursuant to this chapter or otherwise, shall have the meanings set out below.

- A. "City" means the City of Grants Pass, Oregon.
- B. "Council" means the Council of Grants Pass, Oregon.
- C. "Developer" means the City, an individual, a partnership, a joint venture, a corporation, a subdivider, a partitioner of land or any other entity, without limitation, who will bear, under the terms of this chapter, the expense of design, construction, purchase, installation, or other expenses associated with the creation of a public improvement. The rights of a developer, created under this ordinance, also apply to his heirs. (Ord. 15-5663 2015)
- D. "Development" means that real property being developed by the developer and for which property the Reimbursement District Ordinance is adopted.
- E. "Dwelling Unit" means one or more habitable rooms which are occupied or which are intended or designed to be occupied by one family with housekeeping facilities for living, sleeping, cooking and eating.
- F. "Intervening Property" means that real property abutting a public improvement constructed as part of a Reimbursement District, or those properties benefiting from a traffic signal because they were within a specified distance of that signal.(Ord. 5140 §1, 2002)
- G. "Owner" means the fee holder of record of the legal title to the real property in question. Where such real property is being purchased under a recorded land sales contract, then such purchasers shall also be deemed owners. (Ord. 5140 §1, 2002)
- H. "Public Improvement" means the following:
  - 1. Street improvements including the grading, graveling, paving or other

Title 9 Last Revised 8.18.17



## City of Grants Pass Municipal Code

surfacing of any street, or opening, laying out, widening, extending, altering, changing the grade of or constructing any street, the construction of sidewalks, curbs, gutters;

2. Water improvements including the construction or upgrading of any water facilities such as reservoirs or mains;
  3. Sewer improvements including the construction or upgrading of any sanitary sewer facilities such as pump stations or mains.
  4. Drainage improvement including the construction or upgrading of any storm sewer facilities such as detention ponds, or mains;
  5. The installation of traffic signals;
  6. Any other public improvement authorized by the Council or as provided for in State law.
- I. "Reimbursement District" is a method of recapturing costs by a developer, where such developer installs public improvements, and where such public improvements may be utilized by intervening or future properties-
- J. " Reimbursement District Agreement" means an agreement between developer and the City, as authorized by the Council, and executed by the City Manager, which provides for the installation of and payment for public improvements and which agreement contains improvement guarantees, provisions for reimbursement by the intervening properties that may utilize such improvement, inspection guarantees, and the like as determined in the best interest of the public by the Council.
- K. "Reimbursement District Ordinance" means an ordinance adopted by the Council and executed by the City Manager designating the cost for public improvements to be reimbursed and creating a Reimbursement District and containing provisions for financial reimbursement by intervening and future properties that may utilize the improvement and such other provisions as determined in the best interest of the public by the Council. (Ord. 4311 §1, 1979; Ord. 4501, 1984; Ord. 5140 §1, 2002)

### 9.40.020 Receipt of Application

Applications shall be submitted to the City Manager and shall be accompanied by a fee set by resolution. The application must include the name, phone number, and address of the developer, a detailed cost estimate prepared by the developer, engineer, or proposed contractor, and a map of the proposed intervening properties.

An application without the detailed cost estimate will not be considered complete. The City Manager shall determine whether or not the application is complete within



# City of Grants Pass Municipal Code

ten working days of receipt of the application.

The fee will be applied for the cost of administrative analysis of the proposed Reimbursement District, the cost of notifying the property owners recording costs, and such other costs reasonably associated with processing the application. When the City is the developer, the City Manager shall process the application without the fee. (Ord. 5140 §1, 2002)

In order to meet the criteria for the creation of a Reimbursement District, the application shall be deemed complete by the City Manager prior to construction of the infrastructure. (Ord. 5140 §1, 2002)

## 9.40.030 City Manager Analysis

Upon deeming the Reimbursement District application complete, the City Manager shall make an analysis of the reimbursement proposal and shall prepare a report to the Council for discussion at a public hearing. Such report shall include 1) a map showing the proposed District with the location of the development and intervening properties, 2) the acreage, frontage and zoning of each property within the proposed District, 3) an estimate of the total cost of the public improvement and 4) an estimate of the portion of such cost allocated to each property within the proposed District. The report shall recommend a formula for the allocation of costs, and shall address each of the five criteria for approval listed in 9.40.050. (Ord. 5140 §1, 2002)

## 9.40.040 Public Hearing Notification

Not less than fourteen days, nor more than thirty days prior to any public hearing being held pursuant to this chapter, Developer and all intervening property owners shall be notified of such hearing and the purpose thereof. Such notification shall be accomplished by regular mail, or by personal service. If notification is accomplished by mail, notice shall be deemed made on the date said letter of notification is posted. Failure of any owner to be so notified shall not invalidate or otherwise affect any Reimbursement District Ordinance or the Council's action to approve or not to approve the same. (Ord. 4311 §4, 1979; Ord. 4501, 1984; Ord. 5140 §1, 2002)

## 9.40.050 Public Hearing

After the City Manager's analysis has been completed, a public hearing shall be held in which all parties and the general public shall be given the opportunity to express their views and ask questions pertaining to the proposed Reimbursement District. Since Reimbursement Districts do not give rise to immediate assessments, the public hearing is not subject to remonstrances.

The Council will determine if the proposed Reimbursement District meets all of the following criteria:



## City of Grants Pass Municipal Code

- A. Construction did not begin prior to the determination the application was complete.
- B. Developer will pay for the construction of the public improvements.
- C. Public Improvements plans are approved by City Staff and installation will be inspected by City Staff.
- D. Public improvements will have the potential to benefit the properties within the proposed District
- E. The costs are reasonable based on current construction costs.

The Council will have the sole discretion after the public hearing to decide whether or not the proposed District meets the five criteria. If the Council determines the proposal meets the criteria, the Council will determine the boundaries and formula for determining the potential assessment for each property.

### 9.40.060 Reimbursement District Ordinance

After the close of the public hearing, held pursuant to Section 9.40.050, if the Council determines the criteria have been met, it shall adopt an ordinance creating the Reimbursement District and establishing the boundaries, the assessment formula and the estimated assessment for each property within the District. After the ordinance has been adopted, the City Manager shall enter the Reimbursement District and the estimated cost in the City docket. (Ord. 5140 §1, 2002)

### 9.40.070 Reimbursement District Final Ordinance

After the construction has been completed, the Developer shall submit a summary of the final and complete project costs to the City Manager. The submittal shall include copies of the following: construction contract(s), change orders, invoices for professional services such as engineering and surveying, and invoices related to the construction of the facility(s), which shall be used to identify the costs to be included in the Reimbursement District. The cost summary must be submitted within 90 days of the final plat approval or the formal acceptance by the City Engineer (not including maintenance periods) of the public improvement, whichever is later. If the final costs are not submitted within the time limit, the Reimbursement District shall immediately expire without further action.

The City Manager shall verify and analyze said costs, submit a report of the same to the Developer, Intervening Properties and Council. These costs to be reimbursed shall not exceed the estimated cost submitted with the application.

## City of Grants Pass Municipal Code

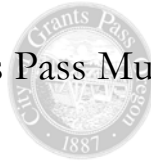

The City Manager will schedule a second hearing for Council consideration of an ordinance to determine the final Reimbursement District total cost to be distributed under the formula previously adopted. The hearing notification shall meet the standards of 9.40. After the public hearing and pursuant to the criteria set forth in 9.40.070 the Final Ordinance shall set the final project costs and the final cost distribution reimbursement for each intervening property.

### 9.40.080 Reimbursement District Agreement

Except when the developer is the City, the Reimbursement District Final Ordinance shall instruct the City Manager to enter into an agreement between developer and the City pertaining to the improvement costs to be reimbursed and may, in such agreement require such guarantee or guarantees as the City deems best to protect the public and intervening properties, and may make such other provisions as the Council determines necessary and proper. All agreements entered into must contain and have distributed costs to all intervening properties. A copy of the agreement must be filed with the Finance Department. (Ord. 5140 §1, 2002)

### 9.40.090 - Notice of Decision

The City notifies the Developer and all Intervening Property owners of the decision of the Council regarding the formation of the District. The notification shall include the distributed costs to all intervening properties. (Ord. 5140 §1, 2002)

### 9.40.100 Imposition of Reimbursement Requirement

(Ord. 17-5726)

The cost distribution reimbursement shall be imposed on all intervening properties for projects that utilize the public improvement installed. Unless specifically prescribed in the ordinance creating the District, the reimbursement shall be due and payable at the time of utilization of the public improvement in the manner prescribed below:

- A. Reimbursement for water improvements shall be due and payable:
  - 1. At the time of application to connect to the installed water line; or
  - 2. In the case of new development approved by any planning action, at the time of the issuance of a development permit, or the filing of a plat, whichever occurs first. Unless connecting to City water, expansion of an existing single-family residence will not require reimbursement.
  
- B. Reimbursement for wastewater improvements shall be due and payable:
  - 1. At the time of application to connect to the installed wastewater line; or
  - 2. In the case of new development approved by any planning action, at the time of the issuance of a development permit, or the filing of a plat, whichever occurs first. Unless connecting to City sewer, expansion of an existing single-family residence will not require reimbursement.

Title 9 Last Revised 8.18.17

# City of Grants Pass Municipal Code

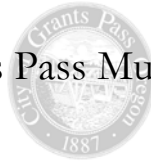

- C. Reimbursement for drainage improvement, street improvement or traffic signal, shall be due and payable at the time of the issuance of:
  - 1. A building permit for a new facility or the expansion of 50% of the square footage of a commercial or industrial building; or
  - 2. A development permit or the filing of a plat when such a permit or plat is required, whichever occurs first. Reimbursement for residential properties will be based upon the number of units being developed as authorized by the permit or final plat (not on the maximum density allowed for the parcel).
- D. The reimbursement for the drainage or street improvements shall not be required if the facility being expanded is a residence or duplex residence.

## 9.40.110 Calculation of Reimbursement - Intervening Properties

- A. The reimbursement for each residential property shall be based on dwelling units and the reimbursement for the non-residential property shall be based on acreage and frontage.

The reimbursement required of each property in the Reimbursement District shall be calculated by first determining the portion of the entire project which shall be charged to the residential properties and the portion of the project to be charged to the non-residential properties. This portion is based on the portion of the frontage and the portion of the acreage. The formula for this is:

- 1) Multiply 50% of the total approved cost times the acreage of all of the residential property divided by the total acreage in the Reimbursement District
- 2) Multiply 50% of the total approved cost times the frontage of all of the residential property along the improvement divided by the sum of the entire frontage along the improvement of all properties within the District.
- 3) The sum of 1) and 2) is the portion of the total cost of the project that is allocated to all of the residential property.
- 4) The remainder is the portion of the total cost of the project that is allocated to all of the non-residential property.

The reimbursement required of each residentially zoned property in the Reimbursement District shall be calculated by dividing the total approved cost of the reimbursable public improvement by 64% of the maximum density of the area of all of the lots within the Reimbursement District. This calculation determines the dwelling unit cost. The reimbursement shall be based on the number of dwelling units requesting connection or the number of dwelling units created or an equivalent thereof. (Ord. 5140 §1, 2002)

# City of Grants Pass Municipal Code



The following table will be used to estimate the number of dwelling units per acre:

R-1-6	8.7 dwelling units (du) per acre
R-1-8	6.2 du per acre
R-1-10	4.8 du per acre
R-1-12	3.96 du per acre
R-2	12.4 du per acre
R-3	17.4 du per acre
R-4	34.8 du per acre

(Ord. 17-5726)

The reimbursement required of each non-residentially zoned property in the Reimbursement District shall be calculated by the following:

- 1) Multiply 50% of the total approved non-residential cost times the acreage of a single piece of property divided by the total non-residential acreage in the Reimbursement District
- 2) Multiply 50% of the total approved non-residential cost times the frontage of a single piece of property divided by the total non-residential frontage along the improvement of all properties within the District.
- 3) The sum of 1) and 2) is the cost for the piece of non-residential property.

For example, the total Reimbursement District includes 40 lots on 30 acres with 1200 feet of frontage. Of these, 25 residential lots on 12 acres are R-1-6 and 10 lots on 8 acres are R-3. The 25 residential lots have a total of 800 feet of frontage. The remaining 5 lots are zoned General Commercial. The General Commercial lots represent 10 acres and 400 feet of frontage. The total project will cost \$900,000.

First determine the cost is allocated to the residential lots and the cost allocated to the non-residential lots. Multiply 50% times total cost times number of acres of residential property divided by total acres. ( $.50 \times 900,000 \times 20 / 30 = \$300,000$ ). Multiply 50% times total cost times frontage of residential property divided by total frontage ( $.50 \times 900,000 \times 800 / 1200 = \$300,000$ ). The total amount for residential properties is \$600,000 (\$300,000 for acreage and \$300,000 for frontage). The remainder, \$300,000, will be allocated to the non-residential properties.

Second, determine the cost for a dwelling unit of residential property. In the example we have a potential of 155 dwelling units. It is 64% of the total number of dwelling units allowed.

# City of Grants Pass Municipal Code



Zone	Max Density	Acres	Adjustment	Dwelling Units (Du)
R-1-6	8.7	12	.64	8.7 x 12 x .64=66 Du
R-3	17.4	8	.64	17.4 x 8 x .64=89 Du
				Total= 155 Du

The cost per dwelling unit is then the total cost for the residential properties divided by the potential number of dwelling units ( $\$600,000 / 155 = \$3,871$  per dwelling unit).

If a developer in this example is creating 10 lots in a subdivision, the developer would be required to pay \$38,710 with the issuance of the development permit (see Section 9.40.070 for a description of the imposition of the fee). In this example, a property owner who is connecting one unit will be required to pay \$3,871.

Third, determine the cost for a non-residential piece of property which is .25 acres and has 50 feet of frontage. The cost per acre is \$3,750 (.50 x 300,000 cost for non-residential x .25 acreage of example property / 10 acres of all non-residential property = \$3,750 for the acreage portion of example property). The cost for the frontage of the example property is \$18,750 (.50 x \$300,000 cost for non-residential properties x 50 feet / 400 feet for all non-residential property = \$18,750 for the frontage portion of example property). The total amount for the example property is \$22,500 ( $\$3,750 + \$18,750 = \$22,500$ ).

- B. Districts involving the cost to install a traffic signal shall be prohibited with the exception of the potential District to install a traffic signal at Highway 238 and Grandview Avenue. For this District, the reimbursement calculations shall be identified in the ordinance, which creates this District.
- C. Reimbursements for odd-shaped lots may be individually established and consistent with the benefit received by the lot and the reimbursement required of other lots in the area, if that consideration is deemed appropriate by the Council. If inequalities are created through the strict implementation of formulas, the Council may modify its impact on a case by case basis.  
(Ord. 5140 §1, 2002)
- D. In every case, the Council may use any other formula for apportioning costs on those intervening properties that is just and reasonable.





9.40.120 Construction Index Applied to Reimbursements

Reimbursements shall be increased by an annual Construction Index rate equal to the average of the previous three years annual CPI for West Coast cities, calculated on an annual basis November through October. This rate shall be established each January and shall be used for all districts created in that calendar year. The rate shall be set forth by Council in the final Reimbursement District Ordinance. The Construction Index shall be calculated from the date the Council adopts the Final Reimbursement District Ordinance to the date of payment of the reimbursement. The rate established for the reimbursement district shall accrue for the first ten (10) years and then run at zero (0.0%) thereafter. (Ord. 5140 §1, 2002) (Ord. 17-5726)

9.40.130 Collection of Reimbursement

The reimbursement is immediately due and payable to the City by intervening property owners subject to 9.40.070 and upon their utilizing the reimbursable public improvement. (Ord. 5140 §1, 2002)

No permit for connection, construction, or development of an intervening property shall be issued until the required reimbursement (see 9.40.070) is paid in full or otherwise processed under the terms of Section 9.40.110. (Ord. 5140 §1, 2002)

9.40.140 Voluntary Imposition of Lien

Whenever reimbursement is due and payable, the intervening property owner may apply, upon forms provided by the City Manager, for the voluntary imposition of a lien upon the parcel for the full amount of the reimbursement unless a Deferred Development Agreement Deposit has been previously paid or is due for the same parcel. If the parcel has previously paid the Deferred Development Agreement deposit or if the parcel is now required to provide a Deferred Development Agreement deposit, that property owner is not eligible and the reimbursement is due and payable in full when imposed according to 9.40.070.

The payment of that lien may be made over a ten or twenty year period in installments, including interest. The City shall determine the interest based on the interest rate paid by the City and the repayment period based on the amount to be repaid. The City shall not permit a lien greater than 25% of the assessed value of the property. (Ord. 5140 §1, 2002)

Upon receipt of the application, the City Manager shall compute the amount of the reimbursement and shall report to the Finance Director the amount of the reimbursement, the date upon which the reimbursement is due, the name of the



## City of Grants Pass Municipal Code

Developer the description of the property and the assessed value of the property; and upon receiving that report, the Finance Director shall docket the lien in the docket of liens. From the time that docketing is completed, the City shall have a lien upon that land. That lien shall be enforced in the manner provided in ORS Chapter 223. (Ord. 4311 §7(c)(2), 1979; Ord. 4501 §1, 1984; Ord. 5140 §1, 2002)

### 9.40.150 Disposition of Reimbursement District funds

Developers shall receive the reimbursement collected by the City for their public improvements with an adopted Reimbursement District within 90 days of receipt by the City. Such reimbursements shall be delivered to developer for a period of 15 years after execution of the reimbursement agreement. (Ord. 5140 §1, 2002)

After 15 years from the effective date of the final ordinance, all rights to reimbursement by the developer shall cease, unless the developer is the City. This section does not preclude the developer from receiving any payments received by the City through the process defined in 9.40.110. and as long as that connection, application for connection, or development of the intervening property is made prior to the close of the 15 year period. The principal reimbursement to the developer shall be no greater than 100% of the approved final costs of the Reimbursement District.

When the City is the developer, the District shall be continued in perpetuity, unless terminated by the Council.

The City shall collect an amount for administrative services performed in collecting and distributing reimbursements. Such administrative fee shall reasonably reflect the service performed and shall be set by resolution. Such fee shall be subtracted from the reimbursement provided to the Developer. The rights to the proceeds from a Reimbursement District are limited to the developer and shall not be appurtenant to any property. A developer may transfer or assign the developer's interest in the proceeds only by notifying the City in writing of the developer's intent. The assignment or transfer shall be on a form reasonably acceptable to the City Attorney. The assignment or transfer shall not be final until the City Attorney has acknowledged it in writing. (Ord. 5140 §1, 2002) (Ord. 15-5663, 2015)

### 940.160 Recording

All Reimbursement District Ordinances and Developer Agreements shall be recorded by the City in the deed records of the County. The ordinance and agreement shall contain full legal descriptions of the development and intervening properties and will include the expiration date of the Reimbursement District created for the private developer. Failure to make such recording shall not affect the legality of a Reimbursement District Ordinance or agreement. (Ord. 4311 §9, 1979; Ord. 4501, 1984; Ord. 5140 §1, 2002)

# City of Grants Pass Municipal Code



## 9.40.170 Public Improvements

Public improvements installed pursuant to Reimbursement District agreements shall become and remain the sole property of the City. (Ord. 4311 §10, 1979; Ord. 4501, 1984; Ord. 5140 §1, 2002)

City of Grants Pass Municipal Code

Chapter 9.44

OFF - STREET PARKING FACILITY ASSESSMENT

Sections:

- 9.44.010 Initiation of Proceedings - Report From City Manager
- 9.44.020 Council's Action on City Manager's Report
- 9.44.030 Resolution and Notice of Hearing
- 9.44.040 Hearing
- 9.44.050 Manner of Doing Work
- 9.44.060 Call for Bids
- 9.44.070 Notice of Proposed Assessment
- 9.44.080 Assessment Ordinance
- 9.44.090 Method of Assessment and Alternative Method of Financing
- 9.44.100 Appeal
- 9.44.110 Notice of Assessment
- 9.44.120 Establishment of Semiannual Installment Payments
- 9.44.130 Lien Records and Foreclosure Proceedings
- 9.44.140 Errors in Assessment Calculations
- 9.44.150 Deficit Assessment
- 9.44.160 Rebates
- 9.44.170 Abandonment of Proceedings
- 9.44.180 Curative Provisions
- 9.44.190 Reassessment
- 9.44.200 Applicability
- 9.44.210 Parking Fund

# City of Grants Pass Municipal Code



## 9.44.010 Initiation of Proceedings - Report From City Manager

Whenever the common Council shall deem it necessary to acquire or develop an off-street public parking facility, upon its own motion or upon the petition of the owners of one-half of the area of property to benefit specially from a proposed off-street motor vehicle parking facility, such area not to include any property upon which is located an existing public commercial off-street parking lot or facility operated for revenue and which is not operated for convenience of customers, or employees or the vehicles of the business upon which it is located, and which the proposed off - street motor vehicle parking facility is to be paid for in whole or in part of special assessment according to the benefits, then the common Council shall, by motion, direct the City manager to make a survey and written report for such project and file the same with the City auditor. Unless the Council shall direct otherwise, such report shall contain, when applicable, the following matters:

- A. A map or plat showing the general nature, location, and extent of the proposed off - street parking facility and the land to be assessed for the payment of any part of the cost thereof;
- B. Plans, specifications, and estimates of the work to be done;
- C. An estimate of the probable cost of the improvement, including any purchase, lease, legal, administrative, and engineering cost attributable thereto;
- D. An estimate of the unit cost of the improvement to the specially benefited properties;
- E. A recommendation as to the method of assessment to be used to arrive at a fair apportionment of the whole or any portion of the cost of the improvement to the properties specially benefited;
- F. The description and assessed value of each lot, parcel of land, or portion thereof, to be specially benefited by said off-street parking facility, with the names of the record owners thereof and, when readily available, the names of the contract purchasers thereof;
- G. A statement of outstanding assessments against property to be assessed.  
(Ord. 3370 §1, 1965)

## 9.44.020 Council's Action of City Manager's Report

After the City Manager's report shall have been filed with the City auditor, the Council may thereafter by motion approve the report, modify the report and approve it as modified, require the City manager to supply additional or different information for such improvement, and shall particularly have the authority to fix the boundaries



## City of Grants Pass Municipal Code

of the assessment District and to find that properties located within the District are particularly and specially benefited by the off-street parking facility, or it may abandon the improvement. (Ord. 3370 §2, 1965)

### 9.44.030 Resolution and Notice of Hearing

- A. After the Council shall have approved the City Manager's report as submitted or modified, the Council shall, by resolution, declare its intention to make such off-street parking facility improvement, provide the manner and method of carrying out the improvement and shall direct the auditor to give notice of such improvement by publishing in a newspaper published in and of general circulation in the City, a notice of its intent to establish an off-street motor vehicle parking facility.
- B. The notice shall be published once a week for two consecutive weeks making two publications in all, and will also be posted in three public places in the City for not less than two consecutive weeks prior to said hearing.
- C. A copy of such notice shall be mailed to the record owner of each parcel of real property within the boundaries proposed to be assessed, at the address of such record owner as contained in the assessment records in the office of the assessor of the county. If the county assessor's records show a purchaser under a land sale contract, such land sale contract purchaser shall be deemed to be the owner.
- D. The notice shall contain the following matters:
  1. That the report of the City manager is on file in the office of the auditor and is subject to public examination;
  2. That the Council will hold a public hearing on the proposed off - street parking facility improvement on a specified date, which shall not be earlier than fourteen days following the first publication of notice, and at which public hearing objections to such improvements will be heard by the Council; and that if prior to such hearing there shall be presented to the auditor written objections by more than one-half of the owners of property proposed to be assessed, based either upon percentage of area or upon the percentage of assessed valuation within the proposed assessment and benefited area, then the improvement will be abandoned for at least one year;
  3. A description of the property to be specially benefited by the improvement, the owners of such property, and the City Manager's estimate of the unit cost of the improvement to the property to be specially benefited, and the total cost of the improvements to be paid for by special assessments to benefited properties. Real property



## City of Grants Pass Municipal Code

within the benefited and improvement area upon which there is located an off-street parking facility operated as a profit making venture for the use of the general public (as distinguished from a parking lot owned or leased and operated primarily as a service and convenience for customers of a particular business) for which a charge is made to the public by the owner or operator thereof, shall not be deemed benefited by the proposed off - street parking facility improvement for which the hearing is held. However, upon the subsequent change of use of said exempted property so that the same is not used for an off - street parking facility operated as a profit making venture for the use of the general public (as distinguished from a parking lot owned or leased and operated primarily as a service and convenience for customers of a particular business) then said property may be assessed its proportionate share of the cost of such off - street parking facility in the manner provided in Sections 9.40.070 and 9.40.080. (Ord. 3370 §3, 1965)

### 9.44.040 Hearing

At the time of the public hearing on the proposed improvement, if the written objections shall represent less than the amount of the property required to defeat the proposed improvement, then, on the basis of the hearing of written and oral objections, if any, the Council may, by motion, at the time of the hearing or at any time thereafter, order the improvement to be carried out in accordance with an ordinance providing therefore, or the Council may, on its own motion, abandon the improvement. (Ord. 3370 §4, 1965)

### 9.44.050 Manner of Doing Work

The Council may provide in the improvement ordinance that the construction work may be done in whole, or in part, by the City, by a contract, or by any other governmental agency, or by any combination thereof. (Ord. 3370 §5, 1970)

### 9.44.060 Call for Bids

- A. The Council may, in its discretion, direct the City manager to advertise for bids for construction of all, or any part of the improvement project on the basis of the Council - approved City Manager's report and before the passage of the ordinance, or after the passage of the ordinance and before the public hearing on the proposed improvement, or at any time after the public hearing; provided, however, that no contract shall be let until after the public hearing has been held to hear objections to the proposed improvement. In the event that any part of the work of the improvement is to be done under contract bids, then the Council shall determine the time and manner of advertisement for bids; and the contracts shall be let to the lowest responsible bidder, provided that the Council shall have the right to reject all bids when they are deemed unreasonable or unsatisfactory. The City shall



## City of Grants Pass Municipal Code

provide for the bonding of all contractors for the faithful performance of any contract let under its authority, and the provisions thereof in case of default shall be enforced by action in the name of the City.

- B. If the Council finds, upon opening bids for the work of such improvement, that the lowest responsible bid is substantially in excess of the City Manager's estimate, it may, in its discretion, provide for holding a special hearing of objections to the proceeding with the improvement on the basis of such bid, and it may direct the City auditor to publish one notice thereof in the newspaper of general circulation in the City. (Ord. 3370 §6, 1965)

### 9.44.070 Notice of Proposed Assessment

Before levying any assessment for an off - street parking facility the Council shall cause the City auditor to mail to each property owner affected by such proposed assessment a notice which shall designate the location of the off - street parking facility, or facilities, for which an assessment is to be made, a description of each lot, part of lot, or other property proposed to be assessed with the name of the owner thereof and the address of the owner as shown on the assessment records of the assessor of the county, and the amount of the assessment. If the county assessor's records show a purchaser under a land sale contract, such land sale contract purchaser shall be deemed to be the owner. The notice shall specify the time and place, when and where the Council will meet to hear the objections to the proposed assessment, and shall request the property owners interested to be present at such time and place to make their objections to the proposed assessment, if any they have. Such notice shall be mailed to each property owner affected by such proposed assessment at the address above indicated, not less than fourteen days prior to the time when the ordinance levying such assessment shall be considered by the Council. A copy of said notices shall be likewise posted by the City auditor in at least three public places in the City, one of which shall be on the bulletin board in the City hall. (Ord. 3370 §7, 1965)

### 9.44.080 Assessment Ordinance

After the aforesaid public hearing on the proposed improvement and after the Council has moved to proceed with the improvement, and after giving notice of such proposed assessment as provided in Section 9.40.070, it may pass an ordinance assessing the various lots, parcels of land, or part thereof, to be specially benefited with their apportioned share of the cost of the improvement; but the passage of such assessment ordinance may be delayed until the contract for the work is let, or until the improvement is completed and the total cost thereof is determined. (Ord. 3370 §8, 1965)



# City of Grants Pass Municipal Code



## 9.44.090 Method of Assessment and Alternative Method of Financing

The Council, in adopting a method of assessment of the costs of the improvement, may:

- A. Use any just and reasonable method of determining the extent of any improvement consistent with the benefits derived;
- B. Use any method of apportioning the sum to be assessed as is just and reasonable between the properties determined to be specially benefited;
- C. Authorize payment by the City of all, or any part, of the cost of any such improvement. (Ord. 3370 §9, 1965)

## 9.44.100 Appeal

Any person aggrieved by the assessment made under this chapter may, within twenty days from the passage of this ordinance levying the assessment by the Council, appeal to the circuit court of the state of Josephine County. Such appeal and the requirements and formalities thereof shall be heard, governed, and determined and the judgment thereon rendered and enforced in the manner provided for appeals from assessments contained in Chapter 223, Oregon Revised Statutes, and any amendments thereto. The result of such appeal shall be a final and conclusive determination of the matter of such assessment, except with respect to the City's right of reassessment as provided in this chapter. (Ord. 3370 §10, 1965)

## 9.44.110 Notice of Assessment

Within ten days after the ordinance levying assessments has been passed, the City auditor shall mail a notice of assessment to the record owners of the assessed property. The notice of assessment shall recite the date of the assessment ordinance and shall state that upon the failure of the owner of the property assessed to make application to pay the assessment in installments within ten days from the date of receipt of the notice, as provided by the provisions of Oregon Revised Statutes, Sections 223.205 to 223.300, entitled Bancroft Bonding Act, or upon the failure of the owner to pay the assessment in full within thirty days from the date of the assessment ordinance, then interest will commence to run on the assessment and the property assessed will be subject to foreclosure; and the notice shall further set forth a description of the property assessed, the name of the owner of the property and the amount of each assessment. (Ord. 3370 §11, 1965)



9.44.120 Establishment of Semiannual Installment Payments

The common Council shall set forth in the assessment ordinance provided in the above section, the number of semiannual installments for a period not to exceed twenty years within which the property owner may make application and agree to pay the assessment with interest at six percent per annum on all the assessments, which have not been paid. The application shall also contain a statement by lots or blocks, or other convenient description of the property of the applicant assessed for the improvement. (Ord. 3370 §12, 1965)

9.44.130 Lien Records and Foreclosure Proceedings

- A. After passage of the assessment ordinance by the Council, the City auditor shall enter in the docket of the City liens a statement of the amounts assessed upon each particular lot, parcel of land thereof, together with a description of the improvement, the name of the record owner and the date of the assessed ordinance.
- B. Upon such entry in the lien docket, the amount so entered shall become a lien and charge upon the respective lots, parcels of land, or portions thereof, which have been assessed for such improvement.
- C. All assessment liens of the City shall be superior and prior to all other liens and encumbrances on property insofar as the laws of the state permit.
- D. Interest shall be charged at the rate of six percent per annum until paid on all amounts not paid within thirty days from the date of the assessment ordinance; and after expiration of thirty days from the date of such assessment ordinance, the City may proceed to foreclose or enforce collection of the assessment liens in the manner provided by the general law of the state and/or as provided in the charter of ordinances of the City; provided, however, that the City may, at its option, enter a bid for the property being offered at a foreclosure sale, which bid shall be prior to all bids except those made by persons who would be entitled under the laws of the state to redeem such property. (Ord. 3370 §13, 1965)

9.44.140 Errors in Assessment Calculations

Claimed errors in the calculation of assessments shall be called to the attention of the City auditor, who shall determine whether there has been an error in fact. If the auditor shall find that there has been an error in fact, he shall recommend to the



## City of Grants Pass Municipal Code

Council an amendment to the assessment ordinance to correct such error, and upon enactment of such amendment, the City auditor shall make the necessary correction in the docket of City liens and send a correct notice of assessment by mail. (Ord. 3370 §14, 1965)

### 9.44.150 Deficit Assessment

In the event that an assessment shall be made before the total cost of the improvement is ascertained and if it is found that the amount of the assessment is insufficient to defray the expenses of the improvement, the Council may, by motion, declare such deficit and prepare a proposed deficit assessment. The Council shall set a time for a hearing of objections to such deficit assessment and shall direct the City auditor to publish one notice thereof in a newspaper of general circulation in the City. After such hearing the Council shall make a just and equitable deficit assessment by ordinance, which shall be entered in the docket of City liens as provided by this chapter, and notices of the deficit assessment shall be published and mailed and the collection of the assessment shall be made in accordance with Sections 9.36.070 and 9.36.110. (Ord. 3370 §15, 1965)

### 9.44.160 Rebates

If, upon the completion of the off - street parking improvement project, it is found that the assessment previously levied upon any property is more than sufficient to pay the costs of such improvement, or at the end of the fiscal year in which the off - street parking improvement is operated, and there is any net income after the payment of the operating costs there from, then the Council must ascertain and declare the same by ordinance, and when so declared, the excess amounts must be entered on the lien docket as a credit upon the appropriate assessments and shall be apportioned and credited to the respective property owners on the same basis and according to the same formula as the original assessment. In the event that any assessment has been paid, the person who paid the same, or his legal representative, shall be entitled to the repayment of such rebate credit, or the portion thereof which exceeds the amount unpaid on the original assessment. (Ord. 3370 §16, 1965)

### 9.44.170 Abandonment of Proceedings

The Council shall have full power and authority to abandon and rescind proceedings for improvements made under this chapter at any time prior to the final completion of such improvements; and if liens have been assessed upon any property under such procedure, they shall be canceled, and any payments made on such assessments shall be refunded to the person paying the same, his assigns or legal representatives. (Ord. 3370 §17, 1965)

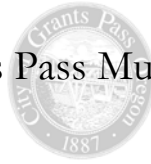

9.44.180 Curative Provisions

No improvement assessment shall be rendered invalid by reason of failure of the City Manager's report to contain all of the information required by Section 9.36.010, or by reason of a failure to have all of the information required to be in the improvement ordinance, the assessment ordinance, the lien docket, or notices required to be published and mailed, nor by the failure to list the name of, or mail notice to, the record owner of any property as required by this ordinance, or by reason of any other error, mistake, delay, omission, irregularity, or other act, jurisdictional, or otherwise in any of the proceedings or steps herein specified, unless it appears that the assessment is unfair or unjust in its effect upon the person complaining; and the Council shall have the power and authority to remedy and correct all such matters by suitable action and proceedings. (Ord. 3370 §18, 1965)

9.44.190 Reassessment

Whenever any assessment, deficit, or reassessment for any improvement which has been made by the City has been, or shall be, set aside, annulled, declared or rendered void, or its enforcement restrained by any court of this state, or any federal court having jurisdiction thereof, or when the Council shall be in doubt as to the validity of such assessment, deficit assessment, or reassessment, or any part thereof, then the Council may take a reassessment in the manner provided by the laws of the state. (Ord. 3370 §19, 1965)

9.44.200 Applicability

The procedures described in this chapter shall be applicable to either the development by the City of an off - street parking facility or to the purchase and/or financing of any existing off - street parking facility. (Ord. 3370 §20, 1965)

9.44.210 Parking Fund

It is the duty of the City auditor to use any revenues from off - street parking facilities to establish a fund called the off - street parking fund and to deposit the same to the credit of the off - street parking fund. All funds from any source received from any off - street parking facility and deposited in said fund shall be used and expended as follows:

- A. To pay the operating and maintenance costs of an off - street parking facility;
- B. Any balance thereafter shall be used to pay off the lien assessment made for an off - street parking facility and said funds to be used pro rata as to each lien assessment;

# City of Grants Pass Municipal Code



- C. Any balance left over after the payment of all operating and maintenance costs and the payment of all lien assessments for an off - street parking facility, shall then be disbursed as the City Council shall direct.  
(Ord. 3370 §21 1965)

City of Grants Pass Municipal Code

Chapter 9.60

HISTORIC LANDMARKS

Section: 9.60      Landmark List

# City of Grants Pass Municipal Code



## 9.60.100 Landmarks

The following buildings are hereby designated Landmarks, and are to be placed as such on the Historic Map:

1. All buildings designated as "exceptional" in the Historic Inventory taken by the Mayor's Advisory Committee on Historic Preservation, dated October 1, 1981; and
2. Those buildings designated as "Landmarks" by the City Council:

122 NE "A" Street  
303 NE "A" Street  
220 NW "A" Street  
310 NW "A" Street  
612 NW "A" Street

412 NW "B" Street  
421 NW "B" Street  
614 NW "B" Street  
619 NW "B" Street  
1800 NE Beacon Drive  
331 SW Burgess Street

219 NW "E" Street  
201 NW Evelyn Street

314 NE Fetzner Street  
989 Fruitdale Drive  
1650 Fruitdale Drive

125 SE "G" Street  
111 SW "G" Street  
115 SW "G" Street  
117 SW "G" Street  
125 SW "G" Street  
129 SW "G" Street  
131 SW "G" Street  
137 SW "G" Street  
139 SW "G" Street  
141 SW "G" Street  
145 SW "G" Street  
147 SW "G" Street  
207 SW "G" Street  
211 SW "G" Street  
229 SW "G" Street  
233 SW "G" Street  
241 SW "G" Street  
509 SW "G" Street

139 SW "I" Street  
417 SW "I" Street

1501 NW Lawnridge Avenue  
1223 NW Lawnridge Avenue  
1304 NW Lawnridge Avenue

821 SE "M" Street

421 SE Riverside Avenue

2030 NW Vine Street

1002 NW Washington Blvd

730 NW 2nd Street

214 NW 3rd Street

604 NW 4th Street  
716 NW 4th Street  
724 NW 4th Street  
750 NW 4th Street  
751 NW 4th Street  
757 NW 4th Street  
758 NW 4th Street  
804 SW 4th Street

612 NW 5th Street  
830 NW 5th Street  
508 SW 5th Street

605 NE 6th Street  
140 NW 6th Street  
208 NW 6th Street  
306 NW 6th Street  
512 NW 6th Street  
762 NW 6th Street

# City of Grants Pass Municipal Code

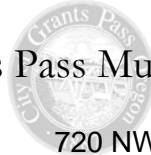

591 SW "G" Street  
1215 SW "G" Street

117 SE H Street  
1021 NW Hawthorne Avenue

720 NW 6th Street  
746 NW 6th Street

701 NE 8th Street  
860 NE 8th Street

1109 NE 9th Street



# City of Grants Pass Municipal Code

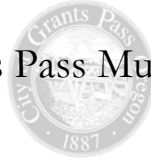

(Ord. #5037 §1, 2000)  
(Ord. #5044 §1, 2001)

## Chapter 9.99

### CLAIMS FILED UNDER BALLOT MEASURE 7

#### Sections:

9.99.010	Purpose
9.99.020	Definitions
9.99.030	Notice of Claim
9.99.040	Appraisal
9.99.050	Completeness Review of Notice of Claim
9.99.060	Procedure to Evaluate Claim
9.99.070	Discretion to Defer City Enforcement
9.99.080	Subsequent Claims
9.99.090	Errors
9.99.100	Rights of Private Attorneys General

# City of Grants Pass Municipal Code

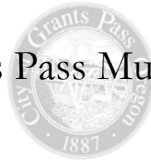

## 9.99.010 Purpose

- A. To create a process for the evaluation of claims filed under the Ballot Measure 7, adopted by the voters in November 2000, as an Amendment to Article I, Section 18, of the Oregon Constitution, and
- B. To enable persons with valid claims an adequate and fair opportunity to present and resolve them in a timely, efficient, thorough, and consistent manner.

## 9.99.020 Definitions

For the purpose of this Chapter 9.99, the following terms, phrases, words and their derivations shall have the meaning given in this section. When not inconsistent with the context, words used in the present tense include the future, words in the plural number include the singular number and words in the singular number include the plural number. Words not defined in Chapter 9.99 shall be given the meaning intended in Article 18, Section 1 of the Oregon Constitution, or as those words may be subsequently defined by Oregon Revised Statute. If not defined there, the words shall be given their common and ordinary meaning.

- A. "Regulation" means a duly adopted City ordinance as codified in the Municipal Code, or any law, rule, ordinance, resolution, goal, or other enforceable enactment of the City of Grants Pass.
- B. "Property Owner" means the owner of title to affected property or the contract purchaser of such property, where the contract is of record.
- C. "Reduction in the Fair Market Value" means the difference in the fair market value of the property before and after application of the regulation including the net cost to the landowner of an affirmative obligation to protect, provide, or preserve wildlife habitat, natural areas, wetlands, ecosystems, scenery, open space, historical, archaeological or cultural resources, or low income housing.
- D. "Affected Property" means the private real property claimed to have a reduction in the fair market value because of a regulation which was adopted, first enforced or applied after the property owner became owner and includes contiguous units of property under the same ownership and any structure built or sited on the property, aggregate and other removable minerals, and any forest product or other crop grown on the property.

# City of Grants Pass Municipal Code

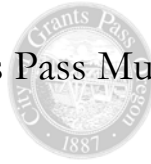

## E. “Exempt Regulation” means;

A regulation which imposes a restriction required under federal law, to the minimum extent required by federal law; or

A regulation prohibiting the use of a property for the purpose of selling pornography, performing nude dancing, selling alcoholic beverages or other controlled substances, or operating a casino or gaming parlor; or

A regulation governing historically and commonly recognized nuisance laws, including those nuisances described in Title 5 of the Grants Pass Municipal Code, as amended from time to time, and the criminal laws of the State of Oregon and the City of Grants Pass.

## 9.99.030 Notice of Claim

- A. A claim arising from the Ballot Measure 7 shall not be considered a claim unless notice of claim is filed as required by this Section and is signed by all owners of fee title (or portions thereof) to the property.
- B. A notice of claim shall be in writing, filed with the City Manager (with a copy to the City Attorney) and shall contain not less than all of the following:
  - 1. The name, address and telephone number of the person filing the claim.
  - 2. The names and addresses of all property owners and all persons who hold a security interest in the affected property.
  - 3. A legal description and street address of affected property including contiguous units of property under the same ownership.
  - 4. Preliminary title report, dated not more than 30 days from the date the claim is filed, from a title insurance company licensed in Oregon.
  - 5. A description of, and citation to, the regulation adopted, first applied or enforced on the affected property causing a reduction in the fair market value.
  - 6. The date regulation was adopted, applied or enforced on the affected property.
  - 7. The date property owner or owners obtained title to property or became contract purchasers of record.



## City of Grants Pass Municipal Code

8. A description of the use that has been restricted by the regulation.
  9. The amount the affected property has suffered a reduction in the fair market value because of the regulation.
  10. Statements explaining why the regulation is not an exempt regulation.
  11. A written appraisal as set forth in section 9.99.040.
  12. Any exempt regulations, known to the claimant that may apply to the affected property, whether or not those exempt regulations affect the fair market value.
  13. A statement explaining how the regulation restricts the use of the affected property and why the regulation has the effect of reducing the fair market value of the property upon which the regulation is imposed.
  14. A statement of the effect a release of the regulation on the property would have on the potential development of the property, stating the greatest degree of development that would be permitted if the identified regulation were released from the property.
  15. If the regulation is a land use regulation, written demonstration that the claimant has previously sought an amendment, repeal, or a variance to the regulation.
  16. A statement of the relief sought by the claimant.
- C. A notice of claim must be accompanied by an application fee of \$3,000 to be paid in advance of acceptance for filing to cover the costs of a complete review of the regulation, an independent appraisal of the property by the City, notices to properties which could be affected by a release of the regulation, hearings to determine the validity of the claim and routine processing of the claim.
- D. The application fee shall be refunded if the City or an appellate body determines that just compensation should be paid based on Ballot Measure 7 or that based on discretion the regulation should not be currently enforced or applied.

### 9.99.040 Appraisal

A written appraisal shall comply with the following specific requirements:

- A. The appraisal shall be performed by an appraiser certified or licensed under ORS Chapter 674 that provides an opinion of the difference in the fair market value of the affected property before and after application of the regulation.

Title 9 Last Revised 8.18.17

## City of Grants Pass Municipal Code



- B. The appraisal shall specifically include and address consideration of the value of the property if all other properties throughout the community are permitted to develop without regulation.
- C. The appraisal shall include a statement that the before value of the property was not reduced by any regulations which were passed, adopted, first enforced or applied to the property on or before December 6, 2000.
- D. The appraisal must expressly note all existing infrastructure limitations and value the property without an assumption that the infrastructure will be improved at governmental expense or through discretionary governmental action.
- E. The appraisal's consideration of the reduction in fair market value shall be limited to the difference in the fair market value of the property before and after the application of the regulation.
- F. The analysis must include the net cost to the landowner of an affirmative obligation to protect, provide, or preserve wildlife habitat; natural areas; wetlands; ecosystems; scenery; open space; historical, archeological, or cultural resources; or low-income housing, except to the minimum extent that a regulation or restriction is necessary to comply with federal law.
- G. The analysis shall not include consideration of any other damage that the regulation may have upon the property in question or any other property owned by the applicant.
- H. The appraisal must expressly consider the effect of the aforesaid Ballot Measure 7 on the availability of other real property including the extent to which the supply of such other real property is or will be increased due to the repeal or waiver of restrictions following the passage of Measure 7.
- I. The appraisal report must clearly state: (1) the assumptions related to the regulation(s) restricting the use(s) of the property; (2) the dates of valuation; (3) the assumptions related to uses allowed on the property if the regulation had not been enacted, enforced, or applied; (4) any statistical, economic, econometric, or other calculations, models, or methods used to determine reduction in value; (5) the comparable properties evaluated; and (6) the methodology used by the appraiser to determine the reduction in fair market value.

# City of Grants Pass Municipal Code

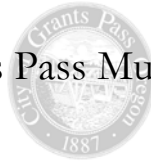

## 9.99.050 Completeness Review of Notice of Claim

A notice of claim shall not be considered a claim until determined to be complete by the City Manager. If the notice of claim is not complete, the City Manager shall inform the claimant in writing of the additional information necessary to make the notice of claim complete. The notice of claim shall be deemed complete at such time as the additional information is submitted and determined complete.

## 9.99.060 Evaluation of the Claim

Claims shall be processed as follows:

- A. Upon the filing of a complete notice of claim, the City Manager shall make a recommendation to the City Council as to disposition of the claim and schedule the matter for consideration by the Council.
- B. Notice of the time and date of a hearing at which the Council will consider the claim shall be mailed to the claimant (and all owners of record of property on the most recent property tax assessment roll where such property is located within 500 feet of the affected property) not less than 10 days prior to the date of consideration. Personal notice to the claimant prior to the 10 days or physical presence of the claimant at the hearing shall be equivalent to mailed notice.
- C. At a public hearing the Council shall consider the information provided by the claimant, information provided by the City staff, and testimony of interested persons testifying at the hearing.
- D. The Council shall not consider any appraisal which is not in compliance with the specific requirements of Chapter 9.99.
- E. If the Council determines compensation is due under Ballot Measure 7, the City shall pay the property owner the amount due or may exercise its discretion as set forth in 9.99.070.

## 9.99.070 Discretion to Defer City Enforcement

- A. After consideration by the Council of the notice of claim and in lieu of paying compensation to the property owner, the City may choose not to officially enforce or apply a regulation except zoning ordinances, the City's Comprehensive Plan, or Statewide Planning Goals. The application of said discretion shall not waive, limit, reduce, or restrict the right of the City to enforce said regulation at some point in the future. The application of said discretion shall not be considered a rescission, withdrawal, or repeal of said regulation. (Ord. 5044 §1, 2001)

## City of Grants Pass Municipal Code

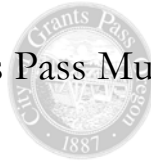

- B. Chapter 9.99 [including Section 9.99.070(A)] do not provide and shall not be interpreted to provide the City of Grants Pass with any legal authority to waive, remove, or fail to enforce or apply zoning ordinances, the City's Comprehensive Plan, or Statewide Planning Goals.  
(Ord. 5044 §1, 2001)

### 9.99.080 Subsequent Claims

- A. If a claim is granted and paid by the City and the claimant does not appeal said amount to the Circuit Court within 90 days, or if on reconsideration an amount is set by the Circuit Court and paid by the City, the claimant and subsequent property owners may not make a subsequent claim for adoption, application or enforcement of the same regulation or a regulation which affects the same use considered and decided in the original claim.
- B. If a claim is denied and the Claimant does not appeal the denial to the Circuit Court within 90 days, the claimant and subsequent property owners may not make a subsequent claim for adoption, application or enforcement of the same regulation or a regulation which affects the same use considered and decided in the original claim.

### 9.99.090 Errors

- A. The failure of the City to follow the procedures noted in Chapter 9.99 shall not result in a default release of the regulation, a default granting of the relief sought, or a default finding of compensation due.
- B. The failure of the City to provide notice to any persons, except notice to the owner of the date of consideration by the Council of the notice of claim, shall not affect or invalidate any proceedings conducted by the City under Chapter 9.99.

### 9.99.100 Rights of Private Attorneys General

If the City during its consideration of the notice of claim in its discretion chooses to defer the enforcement or application of a regulation, persons who are adversely affected by the use put to the property by the owner in violation of said regulation shall be permitted to initiate and maintain a cause of action against the owner of the property for damages in Municipal or Circuit Court.